



INTELLIKNIGHT MODEL 5700

Addressable Fire Control Panel

**Installation and
Operation Manual**

Part Number 151295 A, 05/03

Content

Section 1

Introduction 1-1

- 1.1 Overview of Basic System 1-1
 - 1.1.1 Hardware Features 1-1
 - 1.1.2 Software Features 1-2
- 1.2 About this Manual 1-2
 - 1.2.1 Terms Used in this Manual 1-2
- 1.3 Compatible Products 1-3
- 1.4 How to Contact Silent Knight 1-4

Section 2

Agency Listings, Approvals, and Requirements 2-1

- 2.1 Federal Communications Commission (FCC) 2-1
- 2.2 Underwriters Laboratories (UL) 2-3
 - 2.2.1 Requirements for All Installations 2-3
 - 2.2.2 Requirements for Central Station Fire Alarm Systems 2-3
 - 2.2.3 Requirements for Local Protected Fire Alarm Systems 2-3
 - 2.2.4 Requirements for Remote Station Protected Fire Alarm Systems - Digital Alarm Communicator Transmitter (DACT) 2-3

Section 3

Before You Begin Installing 3-1

- 3.1 What's in the Box? 3-1
- 3.2 Environmental Specifications 3-1
- 3.3 Electrical Specifications 3-2
- 3.4 Wiring Specifications 3-3
- 3.5 Board Assembly Diagram 3-4
- 3.6 Calculating Current Draw and Standby Battery 3-5
 - 3.6.1 Worksheet Requirements 3-5
 - 3.6.2 Current Draw Worksheet 3-6
 - 3.6.2.1 Maximum Battery Standby Load 3-7

Section 4

Control Panel Installation 4-1

- 4.1 Mounting the Control Panel Cabinet 4-1
 - 4.1.1 Removing the IFP-50 Assembly from the Housing 4-1
 - 4.1.2 Dead Front Installation and removal 4-1
 - 4.1.2.1 Installing the Dead Front 4-1
 - 4.1.2.2 Dead Front Removal 4-2
- 4.2 AC Connection 4-3

4.3	Battery Connection	4-4
4.3.1	RBB Accessory Cabinet	4-5
4.3.1.1	Installing the RBB Accessory Cabinet and Batteries	4-5
4.4	SBUS Wiring	4-7
4.4.1	Calculating Wiring distance for SBUS modules	4-7
4.4.2	Wiring Configurations	4-10
4.4.2.1	How to Power SBUS Devices From Auxiliary Power Supply	4-10
4.5	RA-100 Remote Annunciator Installation	4-11
4.5.1	Mounting the RA-100	4-11
4.5.1.1	Flush Mounting	4-12
4.5.1.2	Surface Mounting	4-14
4.6	5824 Serial/Parallel Interface Installation	4-15
4.6.1	Selecting 5824 Options	4-16
4.7	5880 LED Driver Module	4-18
4.7.1	5880 Board Layout	4-18
4.7.2	FACP Connection	4-19
4.7.3	LED Wiring	4-20
4.7.4	Dry Contact Wiring	4-21
4.8	5865-3 / 5865-4 LED Annunciator Installation	4-22
4.8.1	FACP Connection	4-23
4.8.2	5865 Mounting	4-23
4.9	Configuring Modules	4-25
4.9.1	Assigning Module IDs	4-25
4.10	Telephone Connection	4-26
4.11	Notification Appliance/Auxiliary Power Circuits	4-27
4.11.1	Conventional Notification Appliance	4-27
4.11.1.1	Class B Notification Wiring	4-27
4.11.1.2	Class A Notification Wiring	4-28
4.11.2	Auxiliary Power Installation	4-29
4.11.2.1	Door Holder Power	4-29
4.11.2.2	Constant Power	4-30
4.11.2.3	Resettable Power	4-30
4.12	On-Board Relays (Conventional)	4-30
4.12.1	Trouble Relay	4-30
4.12.2	Programmable Relays	4-30
4.13	Remote Station Applications	4-31
4.13.1	Keltron Model 3158 Installation	4-31
4.13.2	City Box Connection Using the 5220 Module	4-32
4.13.3	NFPA 72 Polarity Reversal	4-33
4.13.3.1	Using the 5220 Module	4-33
4.13.4	Using the SD500-ARM Addressable Relay Module	4-35
4.13.5	Using a MR-201/T Control Relay From Air Products	4-36

Section 5

SLC Device Installation

5.1	Types of SLC Devices	5-1
5.2	Maximum Number of Devices	5-2
5.3	Wiring Requirements for SLC Devices	5-2
5.3.1	Wiring SLC devices in Style 4 (Class B)	5-2
5.3.2	Wiring SLC Devices in Style 6 & 7 (Class A)	5-4
5.4	Heat and Smoke Detector Installation	5-5

5.4.1	Wiring	5-5
5.5	Duct Detector Installation	5-6
5.6	Input Monitor Module (SD500-AIM)	5-7
5.7	Mini Input Module (SD500-MIM)	5-8
5.8	Relay Module Installation	5-9
5.8.1	Electrical Specifications	5-9
5.8.2	Wiring	5-9
5.9	SLC Device Addressing	5-10
5.9.1	EEPROM Addressing	5-10
5.9.2	Dipswitch Addressing	5-12

Section 6

Programming Overview 6-1

6.1	JumpStart Autoprogramming	6-1
6.1.1	Input Points	6-2
6.1.2	Output Points	6-2
6.1.3	Running JumpStart	6-2
6.2	Mapping Overview	6-4
6.2.1	Input Point Mapping	6-5
6.2.2	Output Circuit Mapping	6-6
6.2.3	Zone Event Mapping	6-7
6.2.4	Mapping LED Points	6-9
6.3	Silent Knight Software Suite (SKSS)	6-10
6.4	Annunciator Programming	6-10
6.4.1	Entering / Exiting the Program Menu	6-11
6.4.2	Moving through the Menus	6-11
6.4.3	Selecting Options and Entering Data	6-12
6.4.4	Editing Keys	6-12
6.5	Programming Menu Quick Reference	6-13

Section 7

Programming 7-1

7.1	Modules	7-1
7.1.1	Edit Modules	7-1
7.1.1.1	Naming Modules	7-2
7.1.1.2	Module, Wiring Class	7-2
7.1.2	Adding a Module	7-2
7.1.3	Deleting a Module	7-3
7.2	Zone	7-4
7.2.1	Edit Zone	7-4
7.2.1.1	Edit Zone Name	7-4
7.2.1.2	Edit Zone Properties	7-5
7.2.1.3	Zone Outputs	7-7
7.2.1.4	Cadence Patterns	7-9
7.2.2	Add Zone	7-10
7.2.3	Delete Zone	7-10
7.2.4	View Zone Points	7-11
7.3	Group	7-12
7.3.1	Edit Group	7-12

7.3.1.1	Edit Group Name	7-12
7.3.1.2	Edit Group Properties	7-13
7.3.2	Add Group	7-15
7.3.3	Delete Group	7-15
7.3.4	View Group Points	7-16
7.3.5	Edit Output Group Templates	7-17
7.4	Point	7-18
7.4.1	Point Programming For SLC	7-18
7.4.2	Point Programming For Internal or External Power Module (5496)	7-21
7.4.3	Point Programming For 5880 and 5865 Modules	7-22
7.4.3.1	Assigning a Name to a Points	7-23
7.5	System Options	7-25
7.5.1	Reporting Account	7-25
7.5.1.1	Edit Accounts	7-26
7.5.1.2	Auto Test Time	7-28
7.5.2	Phone Lines	7-29
7.5.2.1	Dialing Prefix	7-29
7.5.2.2	Number of Answer Rings	7-30
7.5.2.3	Dial Option (TouchTone or Pulse)	7-30
7.5.2.4	Rotary Format	7-30
7.5.2.5	Line Monitor	7-30
7.5.2.6	Answering Machine Bypass	7-31
7.5.3	Sys. Event Outputs	7-31
7.5.3.1	Trouble Events	7-32
7.5.3.2	System Alarm Cadence	7-33
7.5.4	Day/Night Sensitivity Time	7-33
7.5.5	Holiday Days	7-35
7.5.6	Miscellaneous Options 1	7-36
7.5.6.1	Water Flow Delay	7-36
7.5.6.2	Low AC Report Delay	7-37
7.5.6.3	Automatic Daylight Savings Adjustment	7-37
7.5.6.4	Clock Display Format (AM/PM or Military)	7-37
7.5.6.5	Change AC Line Frequency	7-37
7.5.7	Miscellaneous Options 2	7-38
7.5.7.1	Synchronize Strobes Active During Silence	7-38
7.5.7.2	Auto Display Oldest Event	7-38
7.5.7.3	Report by Zone or by Point	7-38
7.5.8	Miscellaneous Options 3	7-39
7.5.9	Edit Banner Message	7-40
7.6	JumpStart Autoprogramming	7-41
7.7	Computer Account	7-42
7.8	Access Codes	7-43
7.8.1	Profile Edit Menu	7-44
7.8.1.1	Edit Name	7-44
7.8.1.2	Edit Access Code	7-44
7.8.1.3	Panel Functions	7-45

Section 8 System Operation

8.1	Annunciator Description	8-1
8.1.1	LCD Displays	8-1
8.1.2	Banner	8-2

8.2	Menu System	8-2
8.2.1	Main Menu Overview	8-3
8.2.2	Using the Menus	8-3
8.3	Basic Operation	8-3
8.3.1	Setting Time and Date	8-3
8.3.2	Disable / Enable a Point	8-4
8.3.3	View Event History	8-4
8.3.3.1	To clear the event history	8-4
8.3.4	Conduct a Fire Drill	8-4
8.3.5	Conduct an Indicator Test	8-5
8.3.6	Conduct a Walk Test	8-5
8.3.7	Conduct a Dialer Test	8-6
8.3.8	Silence alarms or troubles	8-6
8.3.9	Reset alarms	8-6
8.3.10	Check Detector Through Point Status	8-6
8.3.11	View Status of a Point	8-7
8.3.12	View Alarms or Troubles	8-7
8.3.13	View System Information	8-7
8.3.14	Reset dialer	8-7
8.3.15	Communicating with a Remote Computer	8-8
8.3.16	Working with a Printer	8-9
8.4	Operation Mode Behavior	8-10
8.5	Releasing Operations	8-12
8.5.1	Single Interlock Zone Releasing	8-13
8.5.2	Double Interlock Zone Releasing	8-14

Section 9

Reporting 9-1

9.1	Receivers Compatible with the Control Panel	9-1
-----	---	-----

Section 10

Testing and Troubleshooting 10-1

10.1	Troubleshooting	10-1
10.2	Common Problems	10-1
10.2.1	Event History	10-2
10.3	Built-in Troubleshooting and Testing Tools	10-3
10.3.1	SLC Device Locator	10-3
10.3.2	SLC Multi Locator	10-4
10.3.3	I/O Point Control	10-5

Section 11

Installation Records 11-1

11.1	SLC Point Record	11-1
------	------------------------	------

Appendix A

Compatible Devices A-1

Appendix B

Special Characters ListsB-1

Section 1

Introduction

The 5700 Fire Alarm Control / Communicator is an addressable fire control system that meets the requirements of UL 864.

1.1 Overview of Basic System

The 5700 base system is 50 addressable point system with a built-in annunciator which can also be used to program the system.

1.1.1 Hardware Features

- ï The 5700 panel contains one SLC (Signaling Line Circuit) which supports 50 addressable devices (points).
- ï 2.5A of output power is available through 2 sets of terminals for notification appliance circuits or auxiliary applications. Each circuit is power limited per UL 864 and can source up to 2.5A (total output power for both circuits must not exceed 2.5A).
- ï Built-in dual phone line, digital alarm communicator/transmitter (DACT).
- ï Reports events to central station by point or by zone.
- ï UL Listed for pre-action and deluge releasing systems.
- ï Two general purpose Form C programmable relays.
- ï One Form C Trouble Relay.
- ï Basic system operation can be performed from the on-board, or any remote annunciator.
- ï Up to 20 user profiles can be programmed, each having custom access code, and main menu items.
- ï Can be used with up to 8 Model 5860 Remote Annunciators (sold separately).
- ï Can be used with Model 5865-3, 5865-4, and 5880 in any combination for a total of eight devices on one control panel. See Sections 4.7 and 4.8 for additional information on these models.
- ï Printing of detector status, event history, and real time event log available through the Model 5824 Serial / Parallel Interface (sold separately).
- ï 125 software zones, 125 output groups.
- ï Add 4 Notification/Auxiliary power circuits with each 5496 Intelligent Power Module (up to 8, 5496s per system).

1.1.2 Software Features

- ï Advanced smoke detector features:
 - ñAutomatic drift compensation
 - ñMaintenance alert region
 - ñPoint status eliminates calibrated smoke test requirements for NFPA 72
- ï JumpStart® feature for easy programming
- ï Non-volatile event history stores 1000 events
- ï A choice of output patterns available for notification outputs, including ANSI 3.41 temporal signal
- ï Built-in synchronization appliance support for Faraday, Gentex^Æ, Wheelock^Æ, or System Sensor^Æ.

1.2 About this Manual

This manual is intended to be a complete reference for all installation and operation tasks for the 5700. Please let us know if the manual does not meet your needs in any way. We value your feedback!

1.2.1 Terms Used in this Manual

The following terminology is used with the 5700 system:

Term	Description
SLC	Signaling Line Circuit
Module	The term module is used for all hardware devices except for SLC addressable devices and notification appliances. This includes the 5700 panel itself.
Input Point	An addressable sensing device, such as a smoke or heat detector or a contact monitor device.
Input Zone	A protected area made up of input points.
Output Point (or Output Circuit)	A notification point or circuit for notification appliances. Relay circuits and auxiliary power circuits are also considered output points.
Group (or i Output Groupî)	A group of output points. Operating characteristics are common to all output points in the group.
Output (or i Cadenceî) Pattern	The pattern that the output will use, for example, Constant, March Code, ANSI 3.41. Applies to zones and special system events. See Section 7.5.3.2 for additional information.
Mapping	Mapping is the process of specifying which outputs are activated when certain events occur in the system. Section 6.2 explains mapping in detail.

1.3 Compatible Products

The chart below lists the products available from Silent Knight for use with the 5700.

Type of Device	Model	Description
SLC Devices	SD500-AIM	Contact Monitor Module (switch input). Standard size. (This device replaces Model SD500-FRCM-4. See Note below.)
	SD500-ARM	Relay Module (This device replaces Model SD505-ARM. See Note below.)
	SD500-MIM	Mini Contact Monitor Module (switch input). Small size. (This device replaces Model SD500-FRCM. See Note below.)
	SD500-PS/SD500-PSDA	Single or dual action Addressable pull station
	SD500-LED	The SD500-LED is a LED driver module capable of driving 80 LEDs which connects to the SLC loop on a Silent Knight addressable control panel. Up to 40 SD500-LED modules can be used on the SLC loop.
	SD500-LIM	Short circuit isolator module for SLC devices.
	SD505-6IB	Short circuit isolator base for SD505-AHS, SD505-APS, and SD505-AIS detectors.
	SD505-AHS	Heat Sensor
	SD505-APS	Photoelectric Smoke Detector
	SD505-ADH Duct housing is shipped with a detector base only. Detector head must be ordered separately.	Duct Housing for use with SD505-APS photoelectric smoke detector head. Intake tubing for duct available in 3 lengths: STS-2.5: Duct widths 1.0i to 2.5i STS-5.0: Duct widths 2.5i to 5.0i STS-10.0: Duct widths 5.0i to 10.0i When ordering SD505-ADH, specify intake tubing size and order the appropriate smoke detector, if needed.
	SD505-ADHR	Duct detector housing with relay module. Compatible with the same peripheral devices as the SD505-ADH.
SD505-DTS	Optional remote test station compatible with the SD505-ADHR.	
Other Modules	5824 Serial/Parallel Interface	Allows a printer to be attached for the system for on-site event logging, detector status and event history reports. Two maximum per system.
	5496 Intelligent Power Module	Provides 4 additional Notification Appliance Circuits/Auxiliary power. (Up to 8 per 5700 system.)
	5860 and 5860R Remote Fire Alarm Annunciator	Same operation, similar appearance as on-board annunciator. Up to 8 5860s per system. 5860 is gray; 5860R is red.
	5860TG and 5860TR Trim Ring Kit	Trim ring kits for surface mounting the 5860 annunciator. 5860TG is gray; 5860TR is red.
	5865-3 and 5865-4 LED Annunciator	LED annunciator can display up to 30 LEDs (15 red and 15 yellow). 5865-4 has key switches for silence and reset, and a system trouble LED.
	5880 LED Driver Module	Driver for up to 40 LEDs. Interfaces with customized annunciator boards. In addition the 5880 has eight generic switch input points.
	5883 General Purpose Relay Module	Provides 10 Form C relays. Designed to be driven by the 5880. Up to four, 5883s can be used with each 5880 module.
	7860 Telephone Cord	RJ31X cord for connecting phone line to the 5700.

Type of Device	Model	Description
Software	Silent Knight Software Suite (SKSS) 5660	For communication and panel programming with a Windows-based computer and *modem (not sold by Silent Knight, see Table 1-1 for compatible modems). Enables remote viewing of detector status and event history.
	SKSS Facility Management Software 5670	For remote viewing of detector status and event history. Requires a modem (not sold by Silent Knight).
Misc.	7628	UL Listed End-of-line resistor
	DF-50	Dead Front insert

Note: 5865-3, 5865-4, and 5880 can be used in any combination, up to a total of eight devices on one panel.

The following modems have been tested by Silent Knight for compatibility with the 5700 and the Silent Knight Software Suite software packages:

Table 1-1: Compatible Modems

Manufacturer	Model
US Robotics	28.8
Motorola	LifeStyle
	28.8, 3400 series
	Premier 33.6
Multi-Tech	MT19321ZDX

1.4 How to Contact Silent Knight

If you have a question or encounter a problem not covered in this manual, contact Silent Knight Technical Support at 800-328-0103 (or 763-493-6455). To order parts, contact Silent Knight Sales at 800-446-6444 (or 763-493-6435).

Limitations of Fire Alarm Systems

Manufacturer recommends that smoke and/or heat detectors be located throughout a protected premise following the recommendations of the current edition of the National Fire Protection Association Standard 72 (NFPA 72), manufacturer's recommendations, State and local codes, and the recommendations contained in Guide for the Proper Use of System Smoke Detectors, which is made available at no charge to all installing dealers. A study by the Federal Emergency Management Agency (an agency of the United States government) indicated that smoke detectors may not go off or give early warning in as many as 35% of all fires. While fire alarm systems are designed to provide warning against fire, they do not guarantee warning or protection against fire. A fire alarm system may not provide timely or adequate warning, or simply may not function, for a variety of reasons. For example:

- i Particles of combustion or smoke from a developing fire may not reach the sensing chambers of smoke detectors because:

Barriers such as closed or partially closed doors, walls, or chimneys may inhibit particle or smoke flow.

Smoke particles may become cold, stratify, and not reach the ceiling or upper walls where detectors are located.

Smoke particles may be blown away from detectors by air outlets

Smoke particles may be drawn into air returns before reaching the detector.

In general, smoke detectors on one level of a structure cannot be expected to sense fires developing on another level.

- i The amount of smoke present may be insufficient to alarm smoke detectors. Smoke detectors are designed to alarm at various levels of smoke density. If such density levels are not created by a developing fire at the location of detectors, the detectors will not go into alarm.
- i Smoke detectors, even when working properly, have sensing limitations. Detectors that have photoelectronic sensing chambers tend to detect smoldering fires better than flaming fires, which have little visible smoke. Detectors that have ionizing-type sensing chambers tend to detect fast flaming fires better than smoldering fires. Because fires develop in different ways and are often unpredictable in their growth, neither type of detector is necessarily best and a given type of detector may not provide adequate warning of a fire.
- i Smoke detectors are subject to false alarms and nuisance alarms and may have been disconnected by users. For example, a smoke detector located in or near a kitchen may go into nuisance alarm during normal operation of kitchen appliances. In addition, dusty or steamy environments may cause a smoke detector to falsely alarm. If the location of a smoke detector causes an abundance of false alarms or nuisance alarms, do not disconnect the smoke detector; call a professional to analyze the situation and recommend a solution.
- i Smoke detectors cannot be expected to provide adequate warning of fires caused by arson, children playing with matches (especially within bedrooms), smoking in bed, violent explosions (caused by escaping gas, improper storage of flammable materials, etc.).
- i Heat detectors do not sense particles of combustion and are designed to alarm only when

heat on their sensors increases at a predetermined rate or reaches a predetermined level. Heat detectors are designed to protect property, not life.

- i Warning devices (including horns, sirens, and bells) may not alert people or wake up sleepers who are located on the other side of closed or partially open doors. A warning device that activates on a different floor or level of a dwelling or structure is less likely to awaken or alert people. Even persons who are awake may not notice the warning if the alarm is muffled by noise from a stereo, radio, air conditioner or other appliance, or by passing traffic. Audible warning devices may not alert the hearing-impaired (strobes or other devices should be provided to warn these people). Any warning device may fail to alert people with a disability, deep sleepers, people who have recently used alcohol or drugs, or people on medication or sleeping pills.

Please note that:

- i) Strobes can, under certain circumstances, cause seizures in people with conditions such as epilepsy.
 - ii) Studies have shown that certain people, even when they hear a fire alarm signal, do not respond or comprehend the meaning of the signal. It is the property owner's responsibility to conduct fire drills and other training exercises to make people aware of fire alarm signals and instruct on the proper reaction to alarm signals.
 - iii) In rare instances, the sounding of a warning device can cause temporary or permanent hearing loss.
- i Telephone lines needed to transmit alarm signals from a premises to a central station may be out of service or temporarily out of service. For added protection against telephone line failure, backup radio transmission systems are recommended.
 - i System components, though designed to last many years, can fail at any time. As a precautionary measure, it is recommended that smoke detectors be checked, maintained, and replaced per manufacturer's recommendations.
 - i System components will not work without electrical power. If system batteries are not serviced or replaced regularly, they may not provide battery backup when AC power fails.
 - i Environments with high air velocity or that are dusty or dirty require more frequent maintenance.

In general, fire alarm systems and devices will not work without power and will not function properly unless they are maintained and tested regularly.

While installing a fire alarm system may make the owner eligible for a lower insurance rate, an alarm system is not a substitute for insurance. Property owners should continue to act prudently in protecting the premises and the people in their premises and should properly insure life and property and buy sufficient amounts of liability insurance to meet their needs.

Requirements and recommendations for proper use of fire alarm systems including smoke detectors and other fire alarm devices:

Early fire detection is best achieved by the installation and maintenance of fire detection equipment in all rooms and areas of the house or building in accordance with the requirements and recommendations of the current edition of the National Fire Protection Association Standard 72, *National Fire Alarm Code* (NFPA 72), the manufacturer's recommendations, State and local codes and the recommendations contained in Guide for the Proper Use of System Smoke Detectors, which is made available at no charge to all installing dealers. For specific requirements, check with the local Authority Having Jurisdiction (ex. Fire Chief) for fire protection systems.

Requirements and Recommendations include:

- ï Smoke Detectors shall be installed in sleeping rooms in new construction and it is recommended that they shall also be installed in sleeping rooms in existing construction.
- ï It is recommended that more than one smoke detector shall be installed in a hallway if it is more than 30 feet long.
- ï It is recommended that there shall never be less than two smoke detectors per apartment or residence.
- ï It is recommended that smoke detectors be located in any room where an alarm control is located, or in any room where alarm control connections to an AC source or phone lines are made. If detectors are not so located, a fire within the room could prevent the control from reporting a fire.
- ï All fire alarm systems require notification devices, including sirens, bells, horns, and/or strobes. In residential applications, each automatic alarm initiating device when activated shall cause the operation of an alarm notification device that shall be clearly audible in all bedrooms over ambient or background noise levels (at least 15dB above noise) with all intervening doors closed.
- ï It is recommended that a smoke detector with an integral sounder (smoke alarm) be located in every bedroom and an additional notification device be located on each level of a residence.
- ï To keep your fire alarm system in excellent working order, ongoing maintenance is required per the manufacturer's recommendations and UL and NFPA standards. At a minimum the requirements of Chapter 10 of NFPA 72 shall be followed. A maintenance agreement should be arranged through the local manufacturer's representative. Maintenance should be performed annually by authorized personnel only.
- ï The most common cause of an alarm system not functioning when a fire occurs is inadequate maintenance. As such, the alarm system should be tested weekly to make sure all sensors and transmitters are working properly.

Section 2

Agency Listings, Approvals, and Requirements

2.1 Federal Communications Commission (FCC)

1. The following information must be provided to the telephone company before the 5700 can be connected to the phone lines:

Table 2-1

A	Manufacturer:	Silent Knight
B	Model Number:	5700
C	FCC registration number:	US: AC6AL05B-205700
	Ringer equivalence:	0.5B
D	Type of jack:	RJ31X
E	Facility Interface Codes:	Loop Start: 02LS2 Ground Start: 02GS2
F	Service Order Code:	9.0F

2. This device may not be directly connected to coin telephone or party line services.
3. This device cannot be adjusted or repaired in the field. In case of trouble with the device, notify the installing company or return to:
Silent Knight
7550 Meridian Circle
Maple Grove, MN 55369-4927
763-493-6455
800-328-0103
4. If the 5700 causes harm to the telephone network, the telephone company will notify the user in advance that temporary discontinuance of service may be required. If advance notice is not practical, the telephone company will notify the user as soon as possible. Users have the right to file complaints, if necessary, with the Federal Communications Commission.
5. The telephone company may make changes in its facilities, equipment, operations, or procedures that could affect the operation of the equipment. If this happens, the telephone company will provide advance notice to allow you to make the necessary modifications to maintain uninterrupted service.

Warning

This device has been verified to comply with FCC Rules Part 15. Operation is subject to the following conditions: (1) This device may not cause radio interference, and (2) This device must accept any interference received, including interference that may cause undesired operation.

- a) This equipment complies with Part 68 of the FCC rules and the requirements adopted by the ACTA. On the wiring diagram of this equipment is a label that contains, among other information, a product identifier in the format US: AC6AL05B-205700. If requested, this number must be provided to the telephone company.
- b) See Section 4.10 for phone jack information.
- c) A plug and jack used to connect this equipment to the premises wiring and telephone network must comply with the applicable FCC Part 68 rules and requirements adopted by the ACTA. A compliant telephone cord and modular plug is provided with this product. It is designed to be connected to a compatible modular jack that is also compliant. See installation instructions for details.
- d) The REN is used to determine the number of devices that may be connected to a telephone line. Excessive RENs on a telephone line may result in the devices not ringing in response to an incoming call. In most but not all areas, the sum of RENs should not exceed five (5.0). To be certain of the number of devices that may be connected to a line, as determined by the total RENs, contact the local telephone company. For products approved after July 23, 2002, the REN for this product is part of the product identifier that has the format US: AC6AL05B-205700. The digits represented by ## are the REN without a decimal point (e.g., 03 is a REN of 0.3). For earlier products, the REN is separately shown on the label.
- e) If this equipment 5700 causes harm to the telephone network, the telephone company will notify you in advance that temporary discontinuance of service may be required. But if advance notice isn't practical, the telephone company will notify the customer as soon as possible. Also, you will be advised of your right to file a complaint with the FCC if you believe it is necessary.
- f) The telephone company may make changes in its facilities, equipment, operations or procedures that could affect the operation of the equipment. If this happens the telephone company will provide advance notice in order for you to make necessary modifications to maintain uninterrupted service.
- g) If trouble is experienced with this equipment 5700, for repair or warranty information, please contact Silent Knight (see Section 1.4). If the equipment is causing harm to the telephone network, the telephone company may request that you disconnect the equipment until the problem is resolved.
- h) See warranty in back of this manual for repair and replacement information.
- i) Connection to party line service is subject to state tariffs. Contact the state public utility commission, public service commission or corporation commission for information.
- j) If your home has specially wired alarm equipment connected to the telephone line, ensure the installation of this 5700 does not disable your alarm equipment. If you have questions about what will disable alarm equipment, consult your telephone company or qualified installer.

Electrical Safety Advisory:

Parties responsible for equipment requiring AC power should consider including an advisory notice in their customer information suggesting the customer use a surge arrestor. Telephone companies report that electrical surges, typically lightning transients, are very destructive to customer terminal equipment connected to AC power sources. This has been identified as a major nationwide problem.

2.2 Underwriters Laboratories (UL)

2.2.1 Requirements for All Installations

General requirements are described in this section. When installing an individual device, refer to the specific section of the manual for additional requirements. The following subsections list specific requirements for each type of installation (for example, Central Station Fire Alarm systems, Local Protected Fire Alarm systems, and so on). See Section 8.5 for information on releasing operation.

1. All field wiring must be installed in accordance with NFPA 70 National Electric Code.
2. Use the addressable smoke detectors specified in Section 5.1 of this manual.
3. Use UL listed notification appliances compatible with the 5700 from those specified in the *Appendix* at the back of this manual.
4. A full system checkout must be performed any time the panel is programmed.

2.2.2 Requirements for Central Station Fire Alarm Systems

1. Use both phone lines. Enable phone line monitors for both lines.
2. You must program a phone number and a test time so that the 5700 sends an automatic daily test to the central station.
3. Do not use the ground start option.
4. The AC Loss Hours option must be set from 6-12 hours.
5. The Attempts to Report option must be set for 5.

2.2.3 Requirements for Local Protected Fire Alarm Systems

At least one UL listed supervised notification appliance must be used.

2.2.4 Requirements for Remote Station Protected Fire Alarm Systems - Digital Alarm Communicator Transmitter (DACT)

1. Do not exceed the current load restrictions shown in Section 3.6.2.1.
2. The AC Loss Hours option must be set from 15-30 hours.

Section 3

Before You Begin Installing

This section of the manual is intended to help you plan your tasks to facilitate a smooth installation. Please read this section thoroughly, especially if you are installing a 5700 panel for the first time.

3.1 What's in the Box?

The 5700 ships with the following hardware:

- i A cabinet with all hardware assembled
- i Two keys for the front door
- i Installation and Operation manual P/N 151295.
- i Ten 4.7K ohm end-of-line resistors
- i A battery cable for batteries wired in series

3.2 Environmental Specifications

It is important to protect the 5700 control panel from water. To prevent water damage, the following conditions should be AVOIDED when installing the units:

- i Do not mount directly on exterior walls, especially masonry walls (condensation)
- i Do not mount directly on exterior walls below grade (condensation)
- i Protect from plumbing leaks
- i Protect from splash caused by sprinkler system inspection ports
- i Do not mount in areas with humidity-generating equipment (such as dryers, production machinery)

When selecting a location to mount the 5700 control panel, the unit should be mounted where it will NOT be exposed to temperatures outside the range of 0°C-49°C (32°F-120°F) or humidity outside the range of 10%-85% at 30°C (86°F) noncondensing.

3.3 Electrical Specifications

Table 3-1 list the terminal block on the 5700 as well as a description of the each individual terminal and their respective electrical rating. For location of the terminals refer to Figure 3-2. See also Section 4 for installation.

Table 3-1: Terminal Descriptions

Terminal No.	Label		Description	Rating	
	Group	Individual		Voltage	Current
Terminal Block 1	RELAY 1	NO	Normally open relay contact	24 VDC	2.5 A, resistive
		COM	Common terminal		
		NC	Normally closed relay contact		
	RELAY 2	NO	Normally open relay contact	24 VDC	2.5 A, resistive
		COM	Common terminal		
		NC	Normally closed relay contact		
Terminal Block 2	TELCO 1	RING	Phone Line 1 Telco Ring		
		TIP	Phone Line 1 Telco Tip		
	PHONE 1	RING	Phone Line 1 Phone Ring		
		TIP	Phone Line 1 Phone Tip		
	TELCO 2	RING	Phone Line 2 Telco Ring		
		TIP	Phone Line 2 Telco Tip		
	PHONE 2	RING	Phone Line 2 Phone Ring		
		TIP	Phone Line 2 Phone Tip		
	TROUBLE	NO	Normally open relay contact	24 VDC	2.5 A, resistive
		COM	Common terminal		
		NC	Normally closed relay contact		
	SLC IN	ñ	Used for Class A installations	32 VDC	100 mA
		+			
	SLC OUT	ñ	SLC terminals	32 VDC	100 mA
		+			
	SLC PROG	ñ	Used for programming SLC Detectors	32 VDC	100 mA
		+			
	SBUS	ñ	SBUS Power	24 VDC	0.5 A
		+			
		A	SBUS Communication	5 VDC	100 mA
	B				
	NAC1	ñ	Notification Appliance Circuit/Auxiliary power	24 VDC	2.5 Amp NAC or Aux power
		+			
	NAC2	ñ	Notification Appliance Circuit/Auxiliary power	24 VDC	2.5 Amp NAC or Aux power
+					

3.4 Wiring Specifications

Induced noise (transfer of electrical energy from one wire to another) can interfere with telephone communication or cause false alarms. To avoid induced noise, follow these guidelines:

- i Isolate input wiring from high current output and power wiring. Do not pull one multi-conductor cable for the entire panel. Instead, separate the wiring as follows:

High voltage	AC power Terminals
SLC loops	
Audio input/output	Phone line circuits
Notification circuits	NAC1 through NAC2
SBUS	
Relay circuits	

- i Do not pull wires from different groups through the same conduit. If you must run them together, do so for as short a distance as possible or use shielded cable. Connect the shield to earth ground at the panel. You must route high and low voltages separately.
- i Route the wiring around the inside perimeter of the cabinet. It should not cross the circuit board where it could induce noise into the sensitive microelectronics or pick up unwanted RF noise from the high speed circuits. See Figure 3-1 for an example.
- i High frequency noise, such as that produced by the inductive reactance of a speaker or bell, can also be reduced by running the wire through ferrite shield beads or by wrapping it around a ferrite toroid.

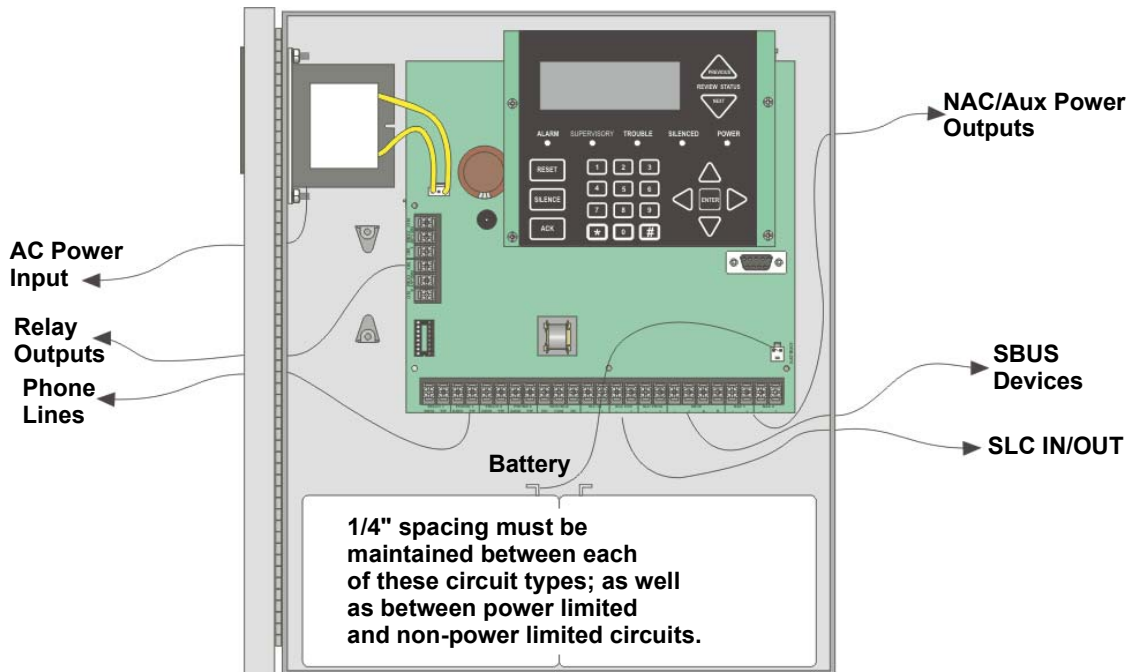

Figure 3-1 Wire Routing Example

3.5 Board Assembly Diagram

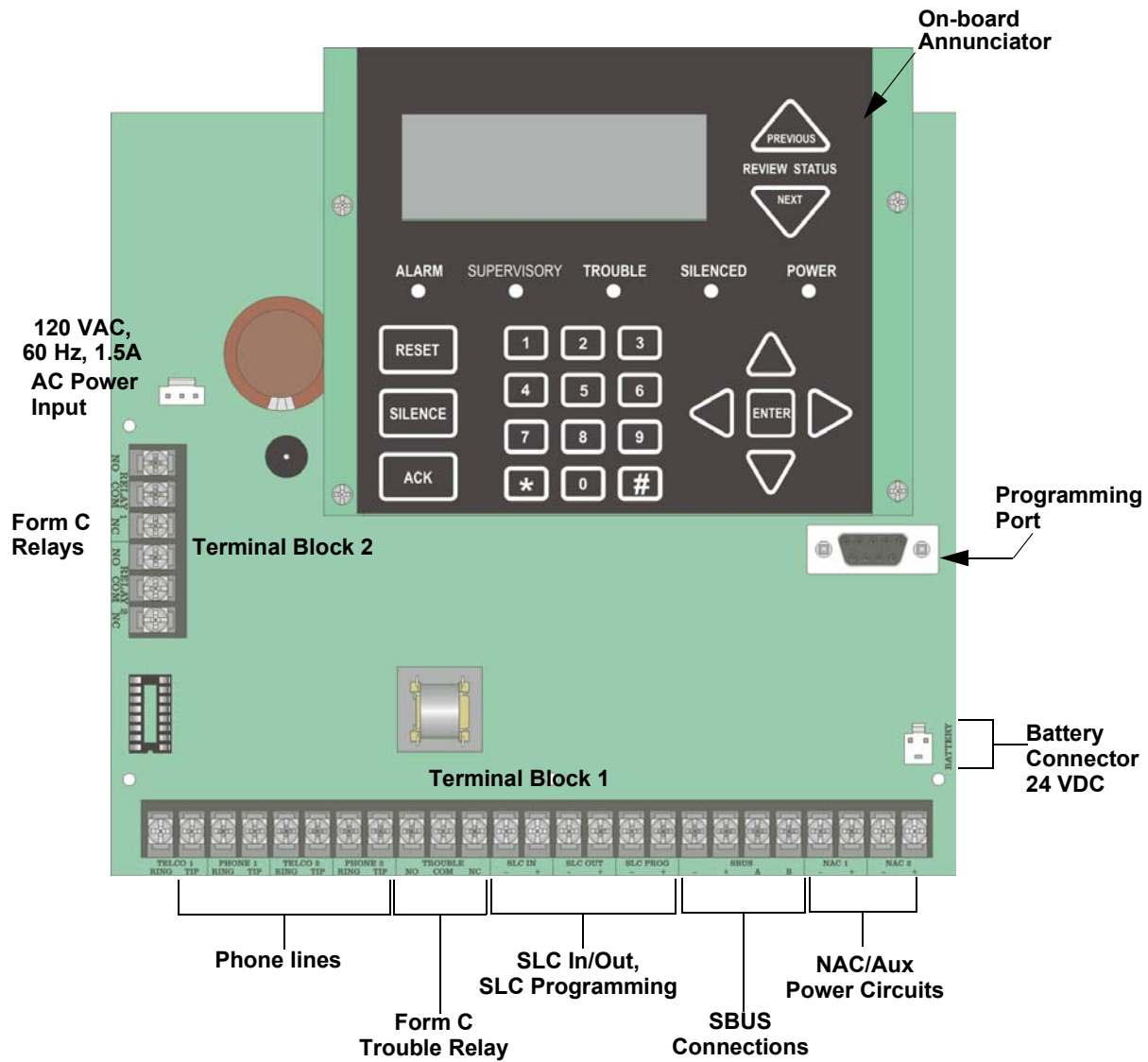

Figure 3-2 Model 5700 Assembly

Figure 3-2 shows the circuit boards, and annunciator. If you should need to remove the control board for repair, remove the three mounting screws which hold the control board in the cabinet. Then lift the control board out of the cabinet.

3.6 Calculating Current Draw and Standby Battery

This section is for helping you determine the current draw and standby battery needs for your installation.

3.6.1 Worksheet Requirements

The following steps must be taken when determining 5700 current draw and standby battery requirements.

Filling in the Current Draw Worksheet, Table 3-2 (Section 3.6.2)

1. For the 5700, the worst case current draw is listed for the panel, addressable devices, and all SBUS expanders. Fill in the number of addressable devices that will be used in the system and compute the current draw requirements for alarm and standby. Record this information in Table 3-2 at Line A.
2. Add up the current draw for all auxiliary devices and record in the table at Line B.
3. Add up all notification appliance loads and record in the table at Line C.
4. For notification appliance circuits and auxiliary devices not mentioned in the manual, refer to the device manual for the current ratings.
5. Make sure that the total alarm current you calculated, including current for the panel itself, does not exceed 2.5 A. This is the maximum alarm current for the 5700 control panel.

If the current is above 2.5 A you will need to use a notification power expander(s) such as the Silent Knight 5496 intelligent power module, to distribute the power loads so that the 5700 or the power expanders do not exceed their power rating. Refer to the current draw worksheets provided with the 5496 manual so you do not exceed their power requirements.

6. Complete the remaining instructions in Table 3-2 for determining battery size requirements.

3.6.2 Current Draw Worksheet

Use Table 3-2 to determine current requirements during alarm/battery standby operation. (Copy the page if additional space is required.)

Table 3-2: Current Calculation Worksheet

Device	# of Devices	Current per Device		Standby Current	Alarm Current
For each device use this formula: This column X This column = Current per number of devices.					
Fire Panel (Current draw from battery)	1	Standby:	206 mA	206 mA	
		Alarm:	356 mA		356 mA
Addressable SLC Devices					
SD500-AIM	**(50 max.)	Standby/Alarm: 0.55 mA		mA	mA
SD500-MIM				mA	mA
SD500-ARM				mA	mA
SD500-PS/SD500-PSDA				mA	mA
SD505-AHS				mA	mA
SD505-APS				mA	mA
SD505-ADHR	(50 max.)	Aux. Pwr	Standby:**35 mA	mA	
			Alarm:**75 mA		mA
SLC		Standby/Alarm:.082 mA	mA	mA	
		None, included with SD505-ADHR worst case.			
SD505-DTS		None, included with detector current.			
SD505-ADH		None, included with detector current.			
SLC Isolator Devices					
SD505-LIM	(100 max.)	Standby/Alarm 0.092 mA		mA	mA
SD505-6IB	(50 max.)				
Accessories Modules					
5860 Remote Fire Alarm Annunciator	(8 max.) See **** Note.	Standby:	20 mA	mA	
		Alarm:	65 mA		mA
5824 Serial / Parallel Module	(2 max.)	Standby/Alarm: 45 mA		mA	mA
5496 Notification Power Expander	(8 max.) See **** Note.	Standby/Alarm: 10 mA		mA	mA
5865-4 LED Annunciator (with reset and silence switches)	(8 max.) See **** Note.	Standby:	35 mA	mA	
		Alarm:	145 mA		mA
5865-3 LED Annunciator		Standby:	35 mA	mA	
		Alarm:	145 mA		mA
5880 Generic LED Driver Module		Standby:	35 mA	mA	
		Alarm:	200 mA		mA
5883 Relay Interface	(32 max.) See **** Note.	Standby:	0 mA	mA	
		Alarm:	220mA (22 mA per relay)		mA
Total System Current					
*Auxiliary Devices Refer to devices manual for current rating.					
		Alarm/Standby:	mA	mA	mA
		Alarm/Standby:	mA	mA	mA
		Alarm/Standby:	mA	mA	mA
		Alarm/Standby:	mA	mA	mA
Auxiliary Devices Current					

A

B

Table 3-2: Current Calculation Worksheet

Device	# of Devices	Current per Device	Standby Current	Alarm Current
Notification Appliance Circuits		Refer to devices manual for current rating.		
		Alarm: mA		mA
		Alarm: mA		mA
		Alarm: mA		mA
		Alarm: mA		mA
Notification Appliances Current				mA
Total current ratings of all devices in system (line A + line B + C)			mA	mA
Total current ratings converted to amperes (line D x .001):			A	A
Number of standby hours (24 or 60 for NFPA 72, chapter 1, 1-5.2.5):			H	
Multiply lines E and F. Total standby AH			AH	
Alarm sounding period in hours. (For example, 5 minutes = .0833 hours)				H
Multiply lines E and H. Total alarm AH				AH
**Add lines G and I. Total ampere hours required			AH	

* If you are using door holders, you do not need to consider door holder current for alarm/battery standby, because power is removed during that time. However, during normal operation, door holders draw current and must be included in the 2.5 A total current that can be drawn from the panel.

** Use next size battery with capacity greater than required.

*** If using Aux power only. No standby or alarm current for battery calculation if using 24 VAC, 120 VAC or 240 VAC.

****Maximum number refer to the maximum numbers that the control panel can communicate with. In some cases the alarm current for the maximum number of devices may exceed the total SBUS current. In these cases an auxiliary power supply must be used. See Figure 4-9 in Section 4 for the correct configuration.

3.6.2.1 Maximum Battery Standby Load

The table below shows the maximum battery standby load for the 5700 based on 24 and 60 hours of standby. The standby load calculations of line D in the Current Draw Calculation Worksheet (Table 3-2) must be less than the number shown in the table below for the battery size used and standby hours required.

Rechargeable Battery Size	Max. Load for 24 hrs. Standby, 5 mins. Alarm	*Max. Load for 60 hrs. Standby, 5 mins. Alarm
7 AH	221 mA	85 mA
18 AH	675 mA	250 mA
33 AH	1.1 A	450 mA

* Required for NFPA 72 Auxiliary Protected Fire Alarm systems for Fire Alarm Service (City Box) and Remote Station Protected Fire Alarm systems (Polarity Reversal) and Digital Alarm Communicator/Transmitter (DACT).

Warning!
Silent Knight does not support the use of batteries smaller than those listed in table above. If you use a battery too small for the installation, the system could overload the battery resulting in the installation having less than the required 24 hours standby power. Use Table 3-2 to calculate the correct battery amperes/hour rating needed for your installation.

Section 4

Control Panel Installation

Caution!

To avoid the risk of electrical shock and damage to the unit, power should be OFF at the control panel while installing or servicing.

4.1 Mounting the Control Panel Cabinet

Read the environmental specifications in Section 3.2 before mounting the 5700 panel.

The 5700 cabinet dimensions are:

12-3/4" W x 15-1/8" H x 3-3/8" D (32.39 cm W x 38.42 cm H x 8.57 cm D).

The 5700 panel should be located within a secured area, where it is accessible to main drop wiring runs and where it can be easily tested and serviced. End-users responsible for maintaining the panel should be able to hear alarms and troubles. When selecting a location, keep in mind that the panel itself is the main source of alarm and trouble annunciation.

When mounting on interior walls, use appropriate screw anchors in plaster. When mounting on concrete, especially when moisture is expected, attach a piece of 3/4 inch plywood to the concrete surface and then attach the 5700 to the plywood. Also mount any other desired components to the plywood.

DO NOT flush-mount the 5700 cabinet in a wall designated as a fire break.

4.1.1 Removing the 5700 Assembly from the Housing

If it should ever be necessary to remove the control panel assembly from the cabinet for repair, do so by removing the screws that hold the control panel in to the cabinet. Do not attempt to disassemble the circuit boards.

4.1.2 Dead Front Installation and removal

This section provides instructions to install and or remove the optional dead front (DF-50) for the control panel cabinet.

4.1.2.1 Installing the Dead Front

Follow these steps to properly install the dead front panel into the control panel cabinet.

1. Remove the top two annunciator screws, do not discard them they will be reused. See Figure 4-1 for annunciator screw location.
2. Set the dead front into the cabinet as shown in Figure 4-1.

3. Reinsert the two annunciator screws as shown in Figure 4-1.

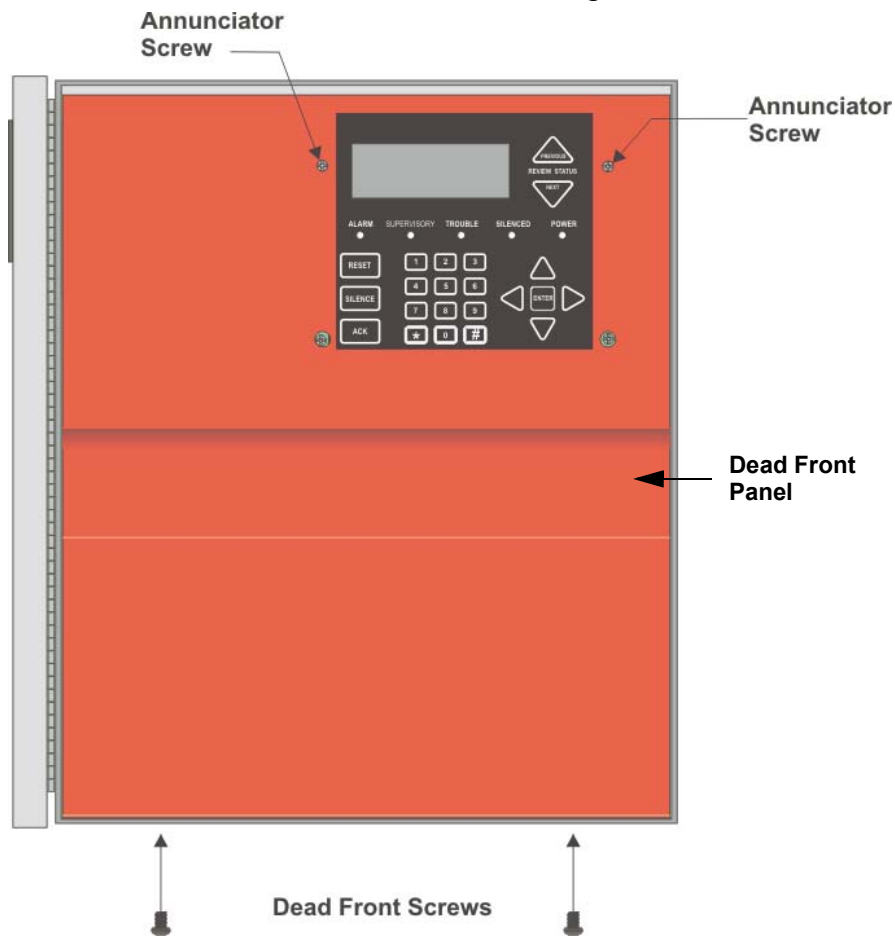

Figure 4-1 Dead Front Installation and Removal

4. Insert the two screws into the bottom of the cabinet to secure the dead front into place. See Figure 4-1.

4.1.2.2 Dead Front Removal

Follow these steps to properly remove the dead front panel from the control panel cabinet.

1. Remove the two annunciator screws, do not discard them. See Figure 4-1.
2. Remove the two screws from the bottom of the cabinet. See Figure 4-1.
3. Remove the dead front panel from the control panel cabinet.
4. Reinsert the two annunciator screws. See Figure 4-1.

4.2 AC Connection

At installation, connect the AC terminals to the power source as shown in Figure 4-2. It may be necessary for a professional electrician to make this connection.

The AC terminals are rated at 120 VAC, 60 Hz, 1.5A .

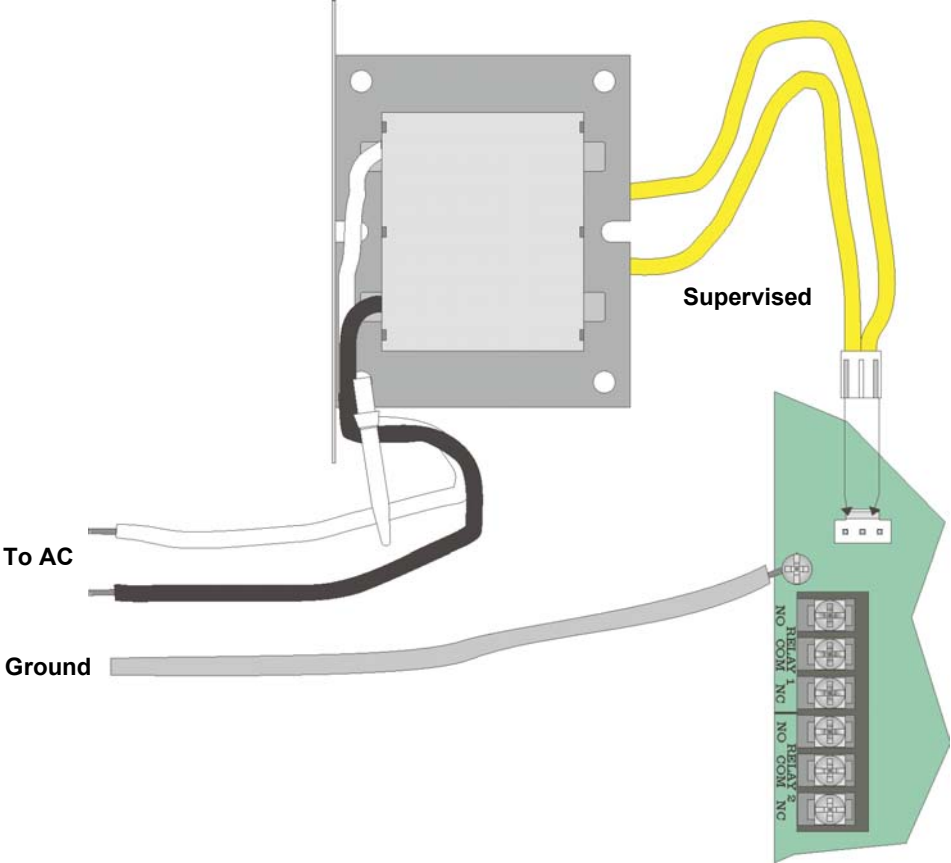

Figure 4-2 120VAC Power Connection

4.3 Battery Connection

The control panel battery charge capacity is 7.0 to 33.0 AH. The main control cabinet can house batteries up to 7 AH, larger capacity batteries can be housed in a Remote Battery Box (P/N RBB). See Section 4.3.1 for details. Use 12V batteries of the same AH rating. Determine the correct AH rating as per your current load calculation (see Section 3.6).

Maximum battery charging current 3.1 Amps.

Wire batteries in series to produce a 24-volt equivalent. Do not parallel batteries to increase the AH rating.

The following steps and diagram explain how to connect the batteries.

1. Connect the black wire from the control panel negative (ñ) battery terminal to the negative (ñ) side of Battery #2.
2. Connect the jumper wire provided (P/N 140694) from the positive (+) side of Battery #2 to the (ñ) negative side of Battery #1.
3. Connect the red wire from the control panel positive (+) terminal to the positive (+) side of Battery #1.

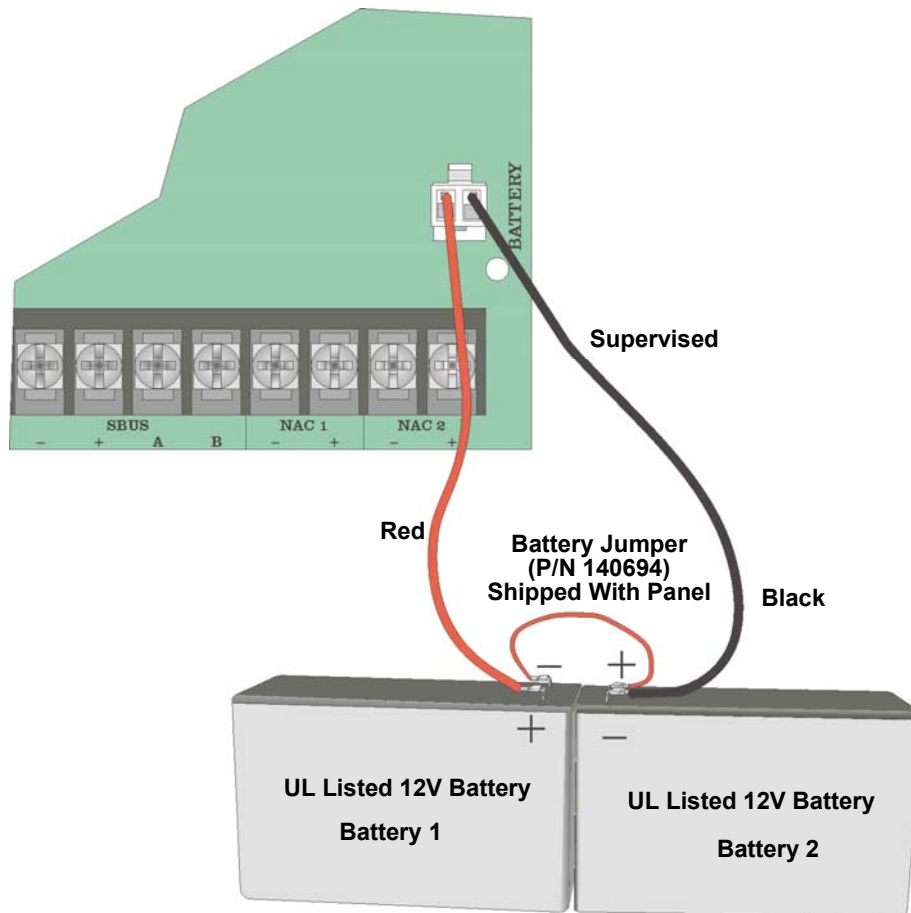

Figure 4-3 Battery Connection

4.3.1 RBB Accessory Cabinet

The Model RBB Accessory cabinet can be used when your backup batteries requirements use backup batteries that are too large to fit into the main control panel cabinet. The RBB cabinet holds batteries up to the 33 AH size. The RBB dimensions are 16" W x 10" H x 6" D (40.64 cm W x 25.4 cm H x 15.24 cm D).

4.3.1.1 Installing the RBB Accessory Cabinet and Batteries

To properly install the accessory cabinet and backup batteries, follow these steps:

1. Mount the accessory cabinet. See figure Figure 4-4 for the four cabinet mounting holes.
 - i If mounting onto drywall the accessory cabinet must be mounted onto 3/4-inch plywood. This is necessary because the weight of the batteries inside the accessory cabinet could cause the cabinet to pull away from the drywall.
 - i When mounting on concrete, especially when moisture is expected, attach a piece of 3/4-inch plywood to the concrete surface and then attach the RBB cabinet to the plywood.
 - i If using the battery cable extenders provided (P/N 140643), mount the RBB cabinet no more than 18" away from the main control panel cabinet. This will ensure that the battery cables reach the battery terminals.

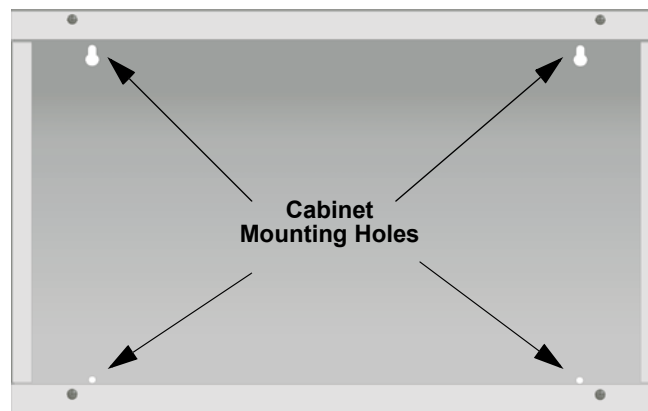

Figure 4-4 RBB Cabinet Mounting Holes

2. Connect the main control panel battery cables to the battery cable extenders as shown in Figure 4-5.

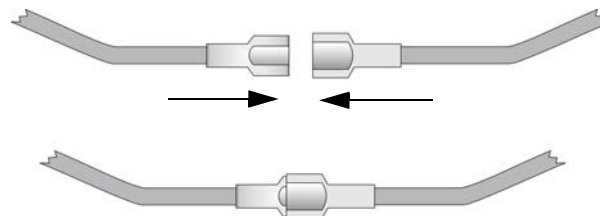

Figure 4-5 Splicing Control panel Battery Cable to RBB Battery Cable Extenders

3. Run extended battery cable from control panel cabinet through conduit to RBB cabinet. See Figure 4-6.

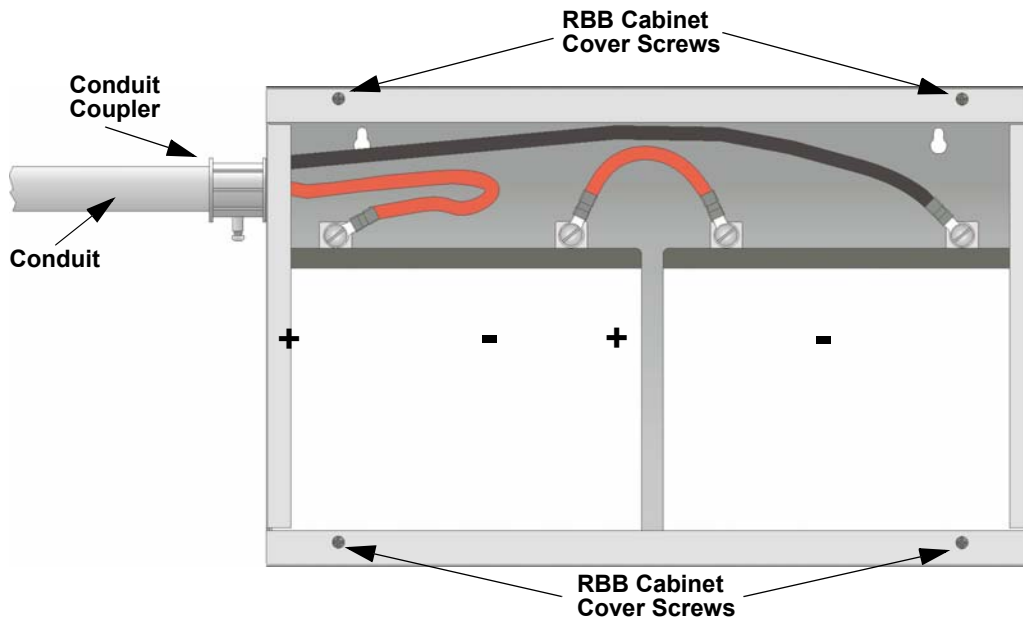

Figure 4-6 Battery Connections in the RBB Cabinet

Note: Figure 4-6 is an example of how the wire connections can be routed. However, any other cabinet knock-outs (on either the main control panel or the RBB cabinet), that are not previously being used may be utilized to connect conduit between the two cabinets.

4. Connect battery leads to the backup battery terminals. See Figure 4-6.
Observe the proper polarity to prevent damage to the batteries or the control panel.
5. Insert the RBB cover screws into the cover mounting holes (see Figure 4-6).
Screw the cover screw 3/4 of the way into the cover mounting hole.
6. Align the cover plate mounting keyhole over the cover mounting screws. See Figure 4-7.

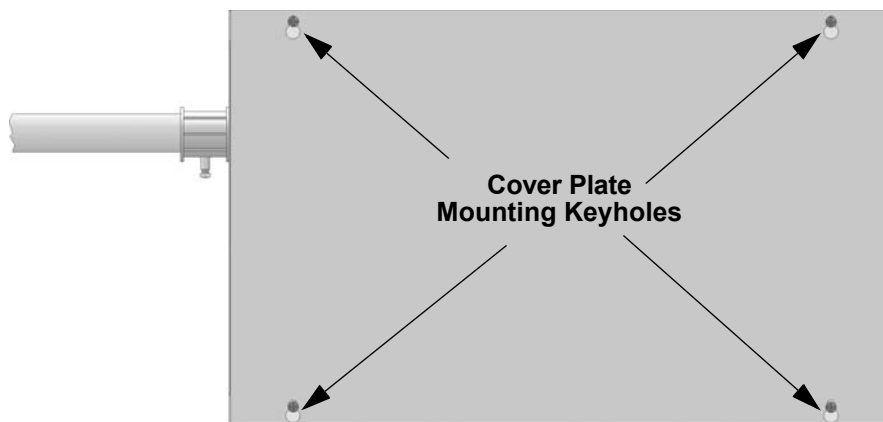

Figure 4-7 Cover Plate Mounting Keyholes and Cover Mounting Screws Alignment

7. Slide the cover into place and tighten the cover mounting screws. See Figure 4-7.

4.4 SBUS Wiring

This section contains information on calculating SBUS wire distances and the types of wiring configurations (Class B).

4.4.1 Calculating Wiring distance for SBUS modules

The following instructions will guide you in determining the type of wire and the maximum wiring distance that can be used with control panel SBUS accessory modules.

To calculate the wire gauge that must be used to connect SBUS modules to the control panel, it is necessary to calculate the total worst case current draw for all modules on a single 4-conductor bus. The total worst case current draw is calculated by adding the individual worst case currents for each module. The individual worst case values are shown in the table below.

Note: Total worst case current draw on a single SBUS cannot exceed 1 amp.

Model Number	Worst Case Current Draw
5860 Fire Annunciator	.100 amps
5824 Parallel/Serial Interface	.040 amps
5880 LED Driver Module	.200 amps
5865 LED Fire Annunciator	.145 amps
5496 Notification Power Supply	.010 amps

After calculating the total worst case current draw, Table 4-1 specifies the maximum distance the modules can be located from the panel on a single wire run. The table insures 6.0 volts of line drop maximum. In general, the wire length is limited by resistance, but for heavier wire gauges, capacitance is the limiting factor.

These cases are marked in the chart with an asterisk (*). Maximum length can never be more than 6,000 feet, regardless of gauge used. (The formula used to generate this chart is shown in the note below).

Table 4-1: Wiring Distances

Wiring Distance: SBUS Modules to Panel				
Total Worst Case Current Draw (amps)	22 Gauge	18 Gauge	16 Gauge	14 Gauge
0.100	1852 ft.	4688 ft.	* 6000 ft.	* 6000 ft.
0.200	926 ft.	2344 ft.	3731 ft.	5906 ft.
0.300	617 ft.	1563 ft.	2488 ft.	3937 ft.
0.400	463 ft.	1172 ft.	1866 ft.	2953 ft.
0.500	370 ft.	938 ft.	1493 ft.	2362 ft.
0.600	309 ft.	781 ft.	1244 ft.	1969 ft.
0.700	265 ft.	670 ft.	1066 ft.	1687 ft.
0.800	231 ft.	586 ft.	933 ft.	1476 ft.
0.900	206 ft.	521 ft.	829 ft.	1312 ft.
1.000 (Max)	185 ft.	469 ft.	746 ft.	1181 ft.

Note: The following formulas were used to generate the wire distance chart:

$$\text{Maximum Resistance (Ohms)} = \frac{6.0 \text{ Volts}}{\text{Total Worst Case Current Draw (amps)}}$$

$$\text{Maximum Wire Length (Feet)} = \frac{\text{Maximum Resistance (Ohms)}}{\text{Rpu}} \quad * 500$$

(6000 feet maximum)

where: Rpu = Ohms per 1000 feet for various Wire Gauges (see table below)

Wire Gauge	Ohms per 1000 feet (Rpu)
22	16.2
18	6.4
16	4.02
14	2.54

Wiring Distance calculation example:

Suppose a system is configured with the following SBUS modules:

2 - Module 5860 Fire Annunciator

1 - 5496 Notification Power Expander

1 - 5865 LED Fire Annunciator

1 - 5824 Parallel/Serial Interface

The total worst case current is calculated as follows:

5860 Current Draw	= 2 x .100 amps	= .200 amps
5496 Current Draw	= 1 x .010 amps	= .010 amps
5865 Current Draw	= 1 x .200 amps	= .145 amps
5824 Current Draw	= 1 x .040 amps	= .040 amps
Total Worst Case Current Draw		= .395 amps

Using this value, and referring to the Wiring Distance table, it can be found that the available options are:

370 feet maximum using 22 Gauge wire

938 feet maximum using 18 Gauge wire

1493 feet maximum using 16 Gauge wire

2362 feet maximum using 14 Gauge wire

4.4.2 Wiring Configurations

Figure 4-8 illustrates Class B configuration.

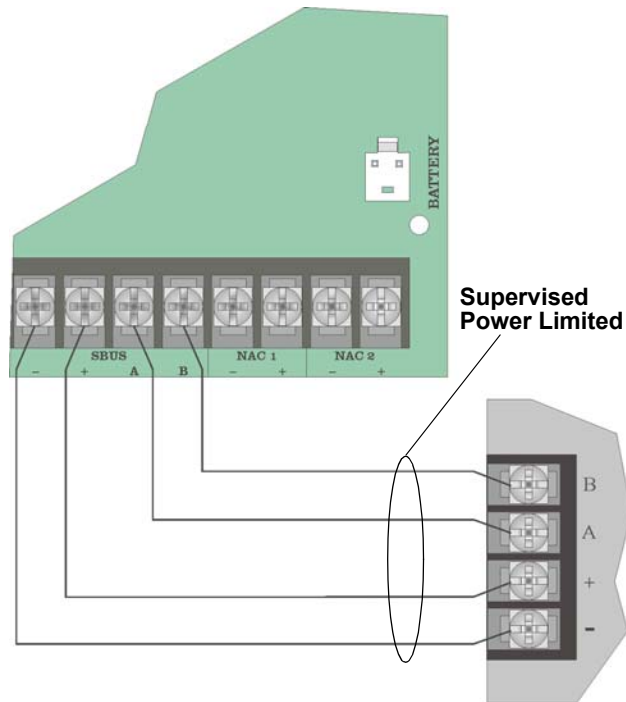

Figure 4-8 SBUS Class B Wiring

4.4.2.1 How to Power SBUS Devices From Auxiliary Power Supply

Figure 4-9 illustrates how to power SBUS devices from an Auxiliary Power Supply such as the 5495 or 5499, when the maximum number of SBUS devices exceeds the SBUS power requirements.

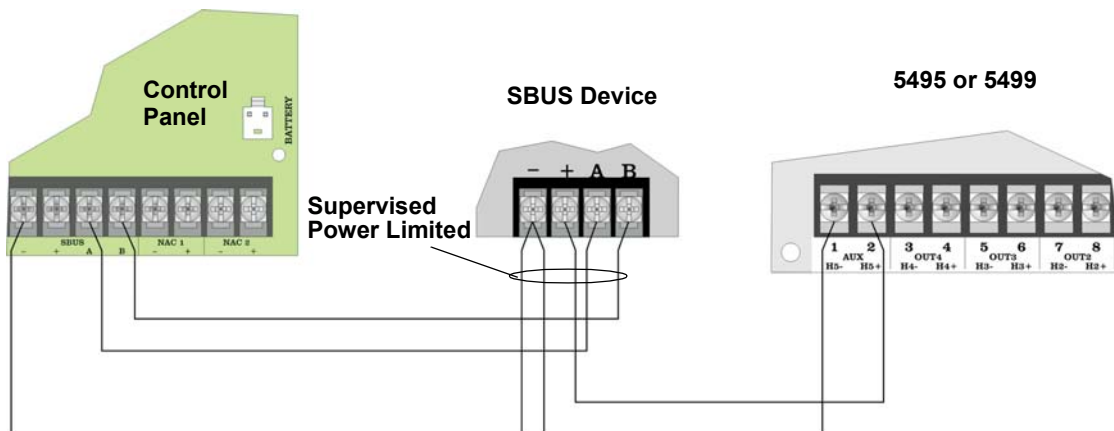

Figure 4-9 Powering SBUS Devices From 5495 or 5499

Note: The earth ground jumper on the 5495/5499 must be removed in this configuration.

4.5 Remote Annunciator 5860 Installation

The optional Model 5860 Remote Annunciator, shown in Figure 4-10, performs the same functions as the on-board annunciator. Operation is identical. Up to 8 annunciators can be added to the 5700 system.

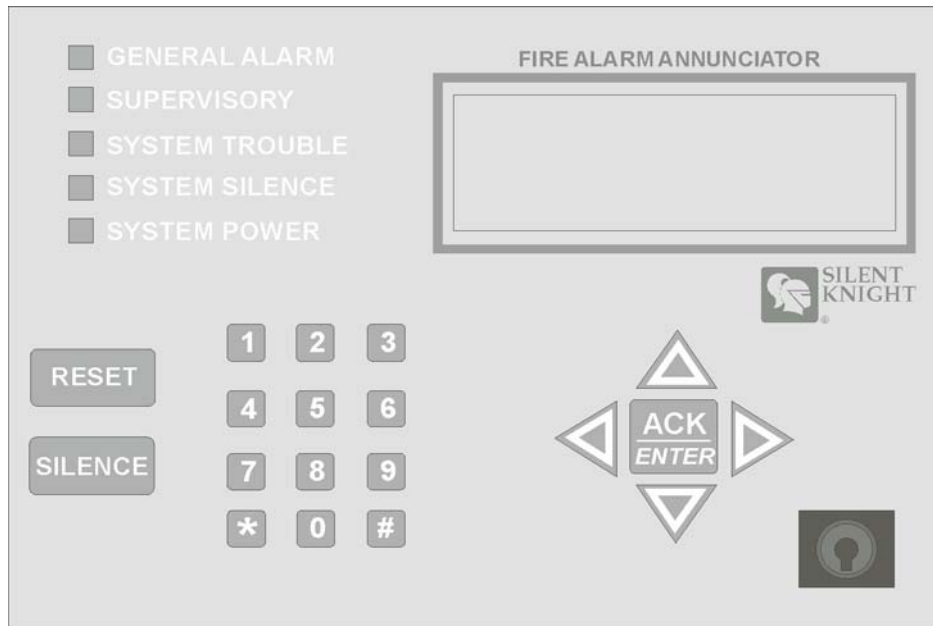

Figure 4-10 Model 5860 Remote Annunciator, Front View

5860 installation involves the following steps:

1. Make sure power is off at the panel.
2. Mount the 5860 in the desired location (see Section 4.5.1).
3. Connect the 5860 to the panel (see Section 4.5.2).
4. Use the dipswitches on the back of the 5860 to assign an ID# to the 5860 (see Section 4.9.1).
5. The new 5860 module must be added to the system through programming. JumpStart will add the module automatically (see Section 6.1). You can also add it manually (see Section 7.1.2). Select a name, if desired (see Section 7.1.1.1).

4.5.1 Mounting the 5860

This section of the manual describes mounting the remote annunciator. The annunciator can be flush- or surface-mounted.

Figure 4-11 shows the parts of the annunciator. Instructions for disassembling and mounting appear on the following pages.

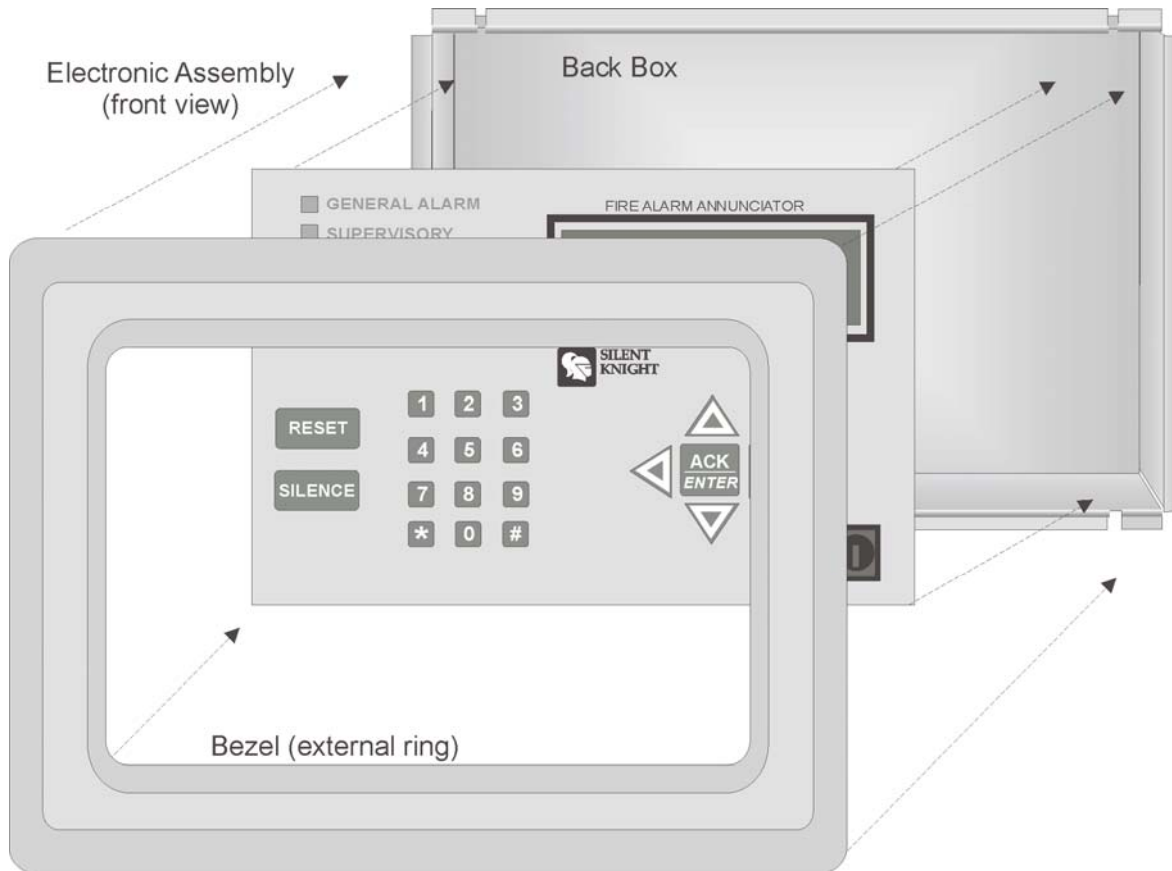

Assembled annunciator also includes mounting wires and 4 set screws.

Figure 4-11 Annunciator Parts

The 5860 comes from the factory fully assembled. You must disassemble it for mounting. To disassemble the annunciator, use a 5/64 hex wrench to remove the set screws, located on the bottom of the annunciator bezel. (See Figure 4-12 for location of the set screws.)

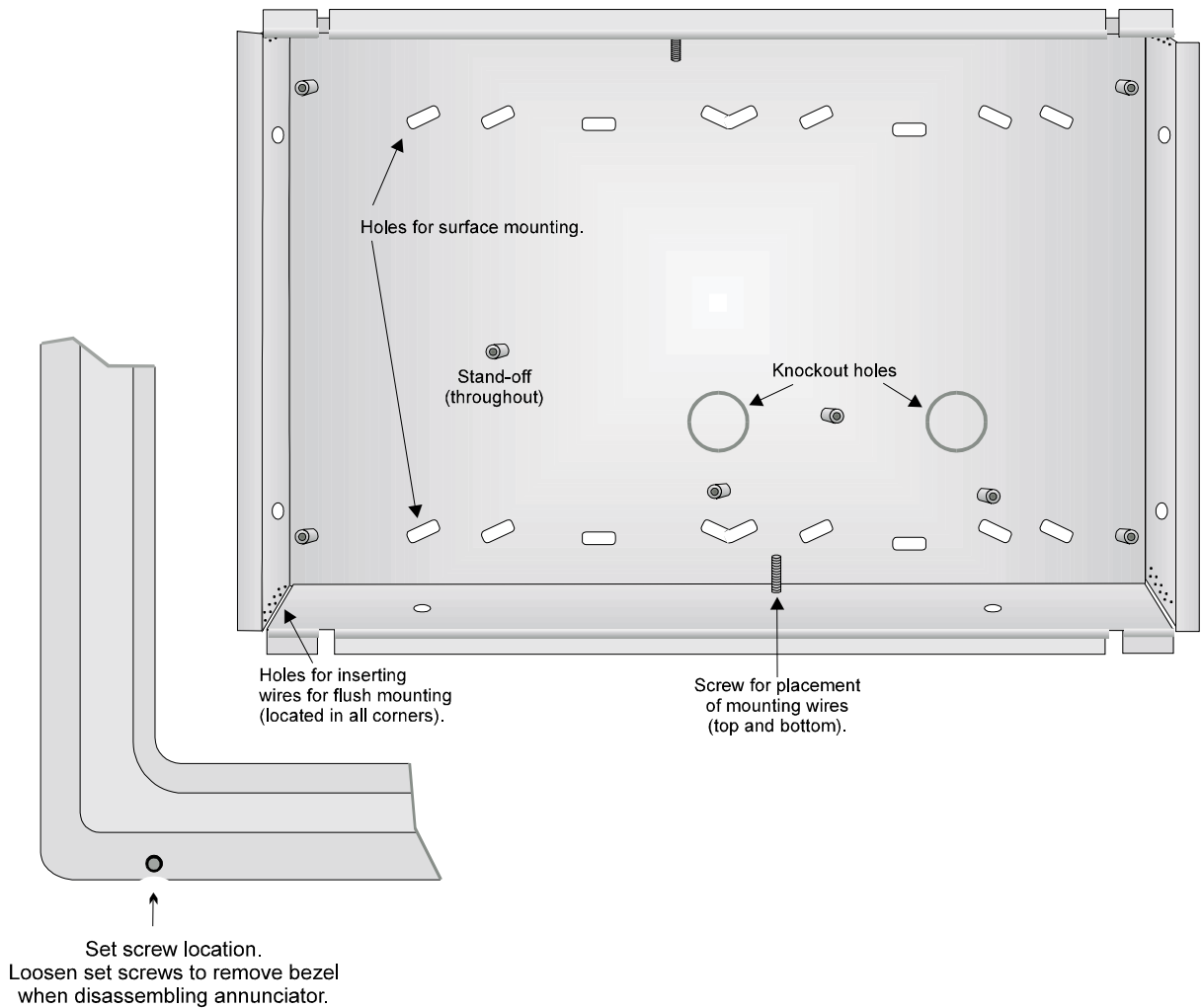

Figure 4-12 Annunciator Back Box and Bezel Details

4.5.1.1 Flush Mounting

This section of the manual describes flush mounting. You can flush-mount with or without an electrical box.

Flush Mounting with an Electrical Box

The 5860 annunciator can be used with the following types of electrical boxes: 4S, single-gang, and double-gang.

If an electrical box is used, the box must be 1-3/8" back from the face of the wall to accommodate the annunciator. Studs used with an electrical box must be two by fours (or larger).

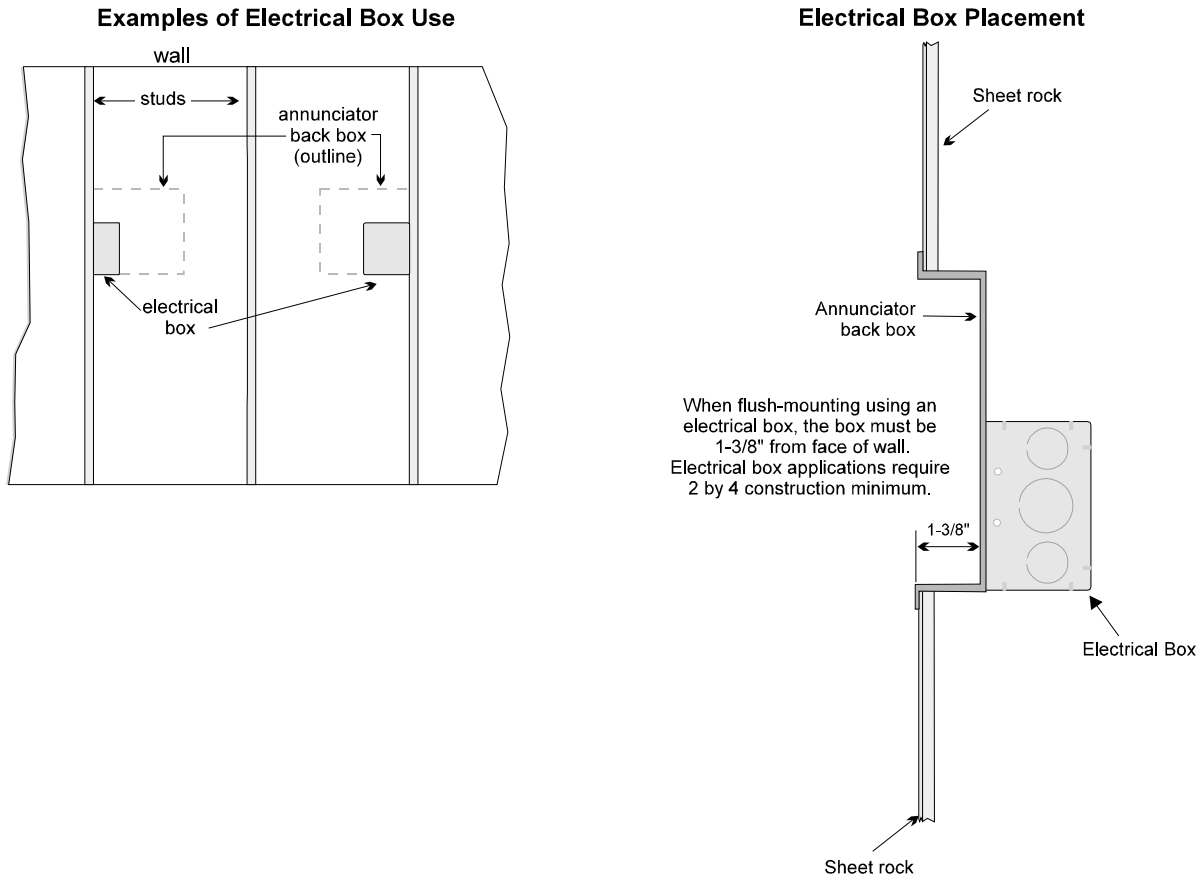

Figure 4-13 Placement of Electrical Box for Flush Mounting

Flush Mounting Steps

1. Cut a hole in the sheet rock to the following dimensions: 8-1/4" w x 6-5/8" h. If an electrical box is used, the box must be 1-3/8" back from face of wall to accommodate the annunciator (see Figure 4-13).
2. Remove knockout holes as needed for wires.
3. Fit the annunciator back box into the hole and stabilize with mounting wires. Angle the mounting wires into the first hole past the sheet rock. Secure the wires behind the screws as shown in Figure 4-14. When all four wires are in place, the back box should fit snugly into the hole in the sheet rock.

4. After the annunciator wiring to the panel has been completed (described in Section 4.5.2), replace the electronic assembly in the back box. Place the bezel over the back box and tighten the set screws on the bezel.

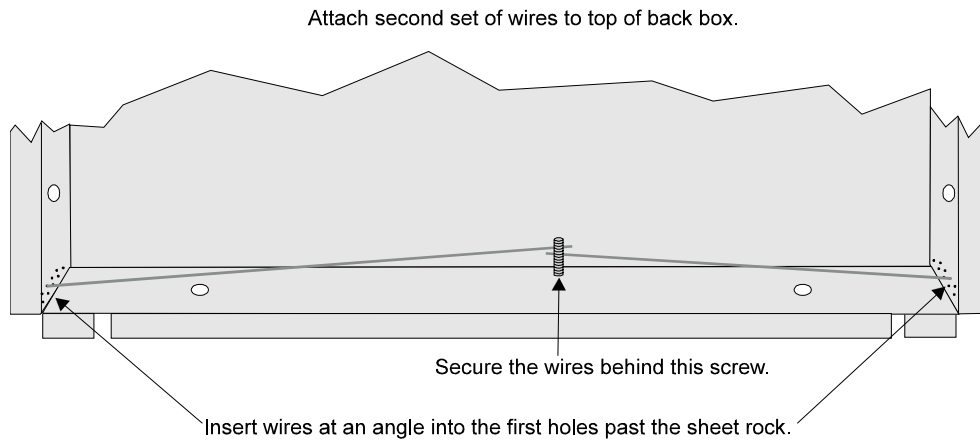

Figure 4-14 Flush Mounting the Back Box

4.5.1.2 Surface Mounting

The 5860 can be mounted directly to a surface or can be attached to a single, double, or four-square electrical box. The Model 5860TG/TR trim ring kit is available for use when surface mounting.

1. Drill holes in the surface to match the screw holes on the back box.
2. Fit the trim ring over the back box.
3. Attach the back box to the surface using screws provided.
4. After the annunciator wiring to the panel has been completed (described in Section 4.5.2), replace the electronic assembly in the back box. Place the bezel over the back box and tighten the set screws on the bezel.

4.5.2 Model 5860 Connection to the Panel

Connect the 5860 to the panel as shown in Figure 4-15.

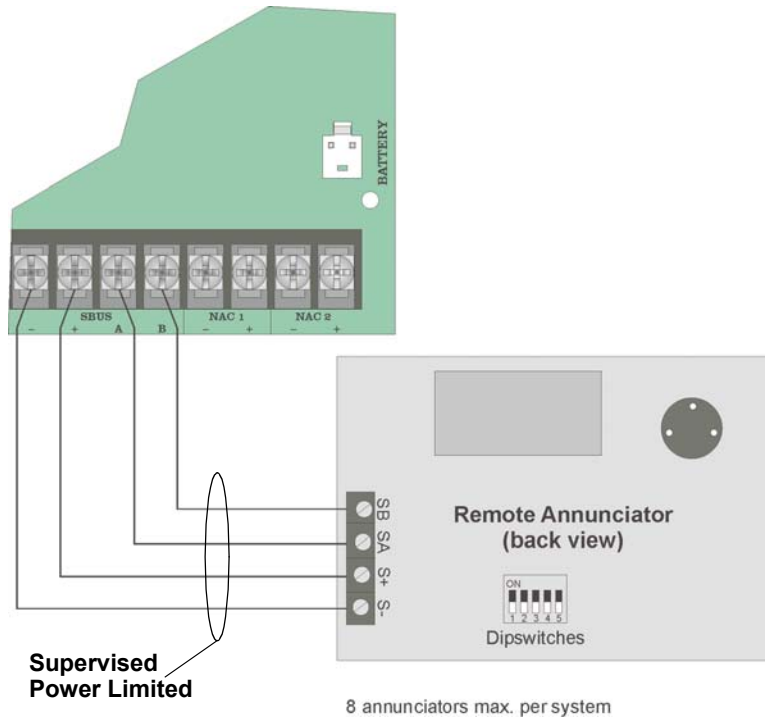

Figure 4-15 Model 5860 Connection to the Panel

4.6 5824 Serial/Parallel Interface Installation

The 5824 Serial / Parallel Interface allows you to connect a printer to the panel, so you can print a real-time log of system events, a report of detector status, and event history. Instructions for installing the 5824 appear below.

5824 installation involves the following steps:

1. Make sure power is off at the panel.
2. Connect the 5824 to the panel as shown in Figure 4-16.

Note: Two 5824s per panel maximum.

3. Use the dipswitches on the back of the 5824 board to assign an ID# to the 5824 (see Section 4.9.1).
4. Configure the 5824 device through programming. See Section 4.6.1.

5. Connect a printer to the 5824 as shown in Figure 4-17.

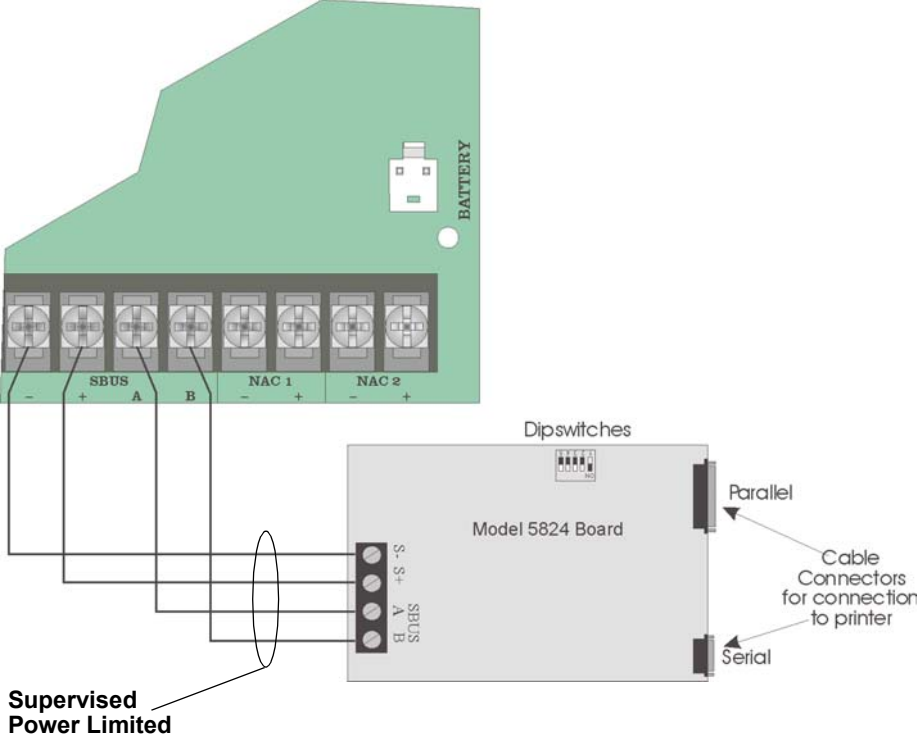

Figure 4-16 5824 Connection to the Panel

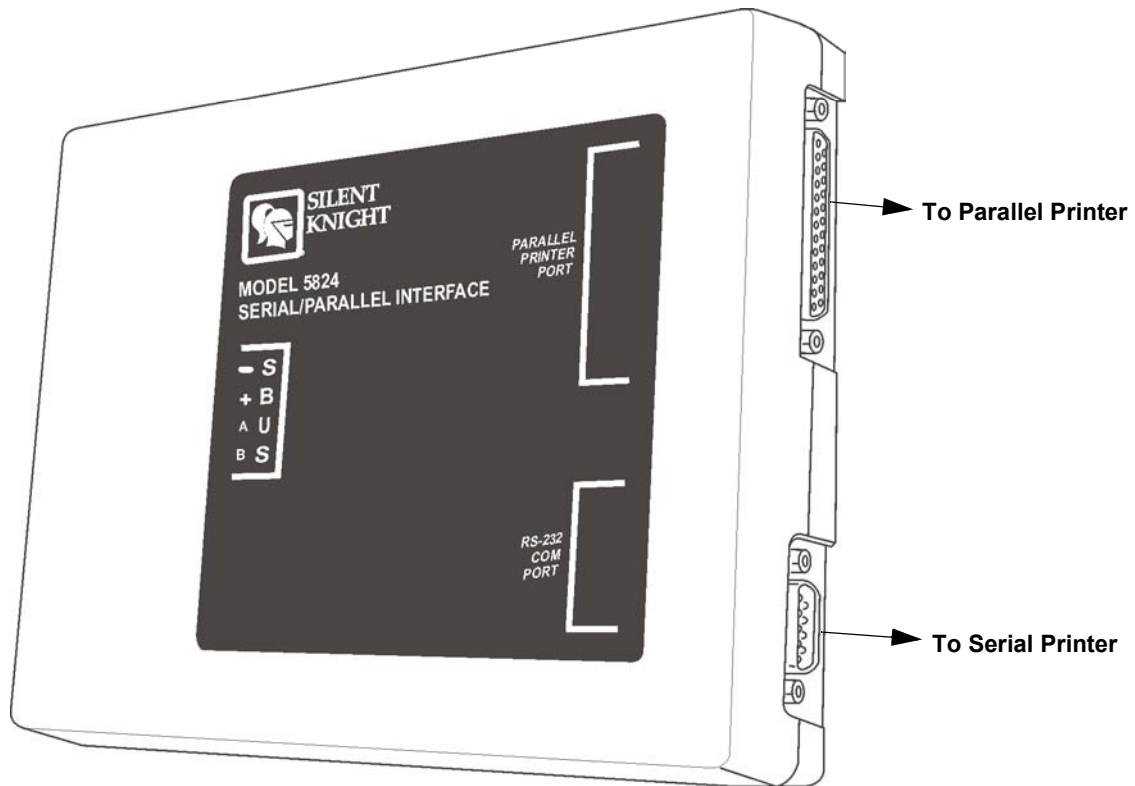

Figure 4-17 Printer Connection

4.6.1 Selecting 5824 Options

Configuring the 5824 includes the following steps:

- i Add the module to the system. JumpStart will add the module automatically (see Section 6.1). You can also add it manually (see Section 4.9).
- i Select a name, if desired (see Section).
- i Select options for the printer and the output port. See below.

Printer and Output Port Options

1. From the Main Menu, select **7** for Program Menu.
2. Select **1** for Module.
3. Select **1** for Edit Module.
4. From the list that displays, select the 5824 module you want to configure.
5. Press **ENTER** **ENTER** to bypass the next two screens. A screen similar to the one shown in Figure 4-18 will display.

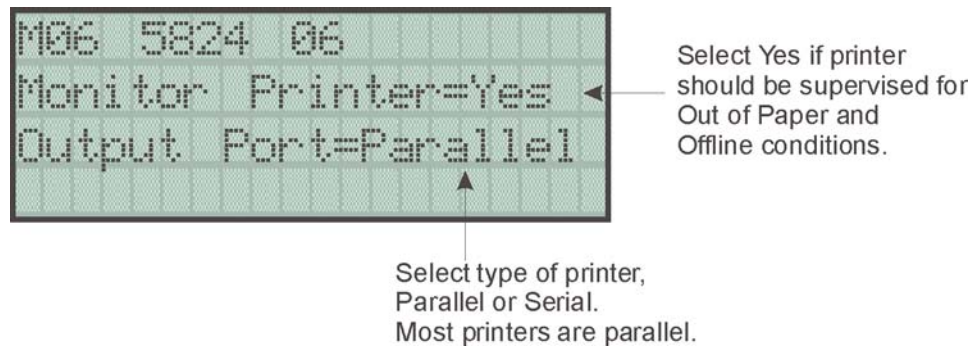

Figure 4-18 Selecting Printer and Output Port Options

6. Select options for the printer as needed for your installation. Most printers are parallel.
7. If you are using a serial printer, use the next screen to select serial port options as required for your printer. Refer to your printer manual if you need more information.

Option	Choices
Baud Rate:	75 - 19200
Data Bits:	5 - 8
Stop Bits:	.5, 1, 2
Parity:	None, Even, Odd

4.7 5880 LED Driver Module

The 5880 is an LED driver board that can be used in a wide variety of applications, including as an interface with most customized floor plan annunciator boards. The 5880 can drive up to 40 LEDs and has one PZT controller. The 5880 also has eight inputs for dry contact monitoring. The following sub-sections describe hardware installation. Refer to Section 6 for programming information.

4.7.1 5880 Board Layout

Figure 4-19 is a picture of the 5880 board showing locations of screw terminals for connection to the panel and contact monitor wiring; pin connectors for connecting LEDs; and the dipswitch for selecting an SBUS ID number.

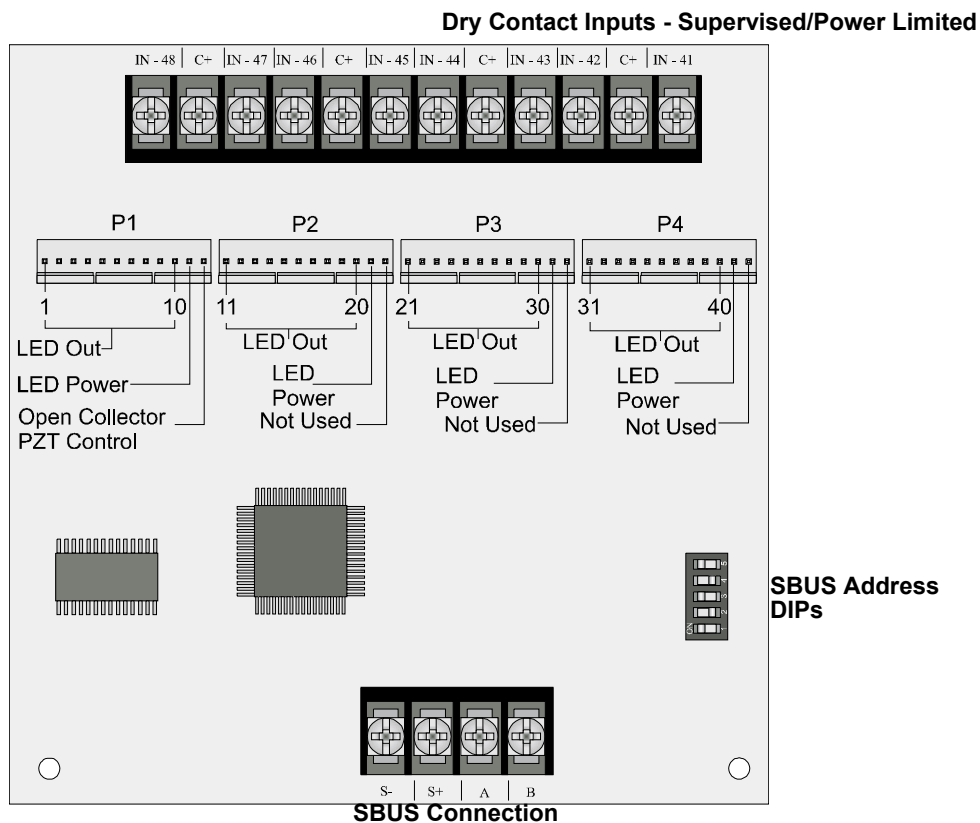

Figure 4-19 5880 Board Layout

4.7.2 FACP Connection

The 5880 connects to the panel via the SBUS. Make connections as shown in Figure 4-20. After the 5880 is connected to the panel, it must be added to the system. This programming step is described in Section 4.9.

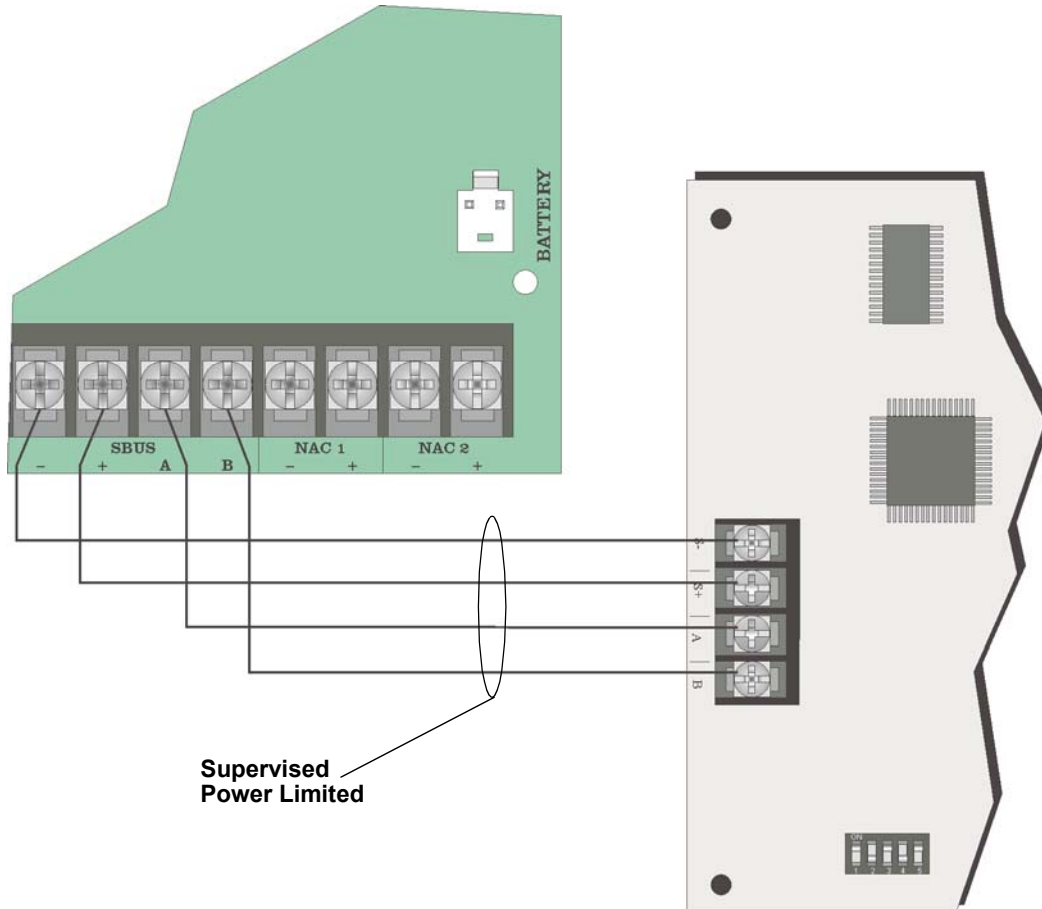

Figure 4-20 5880 Connection to Main Control Panel Assembly

4.7.3 LED Wiring

There are four 12-pin connectors on the 5880 board for connecting LEDs. Each LED gets its power from Pin 11. Internal resistors are sized so that there is approximately 10 mA of current for each LED, no series resistors are required. LED outputs can be mapped to output circuits. See Section 6 for programming details.

Wire the LEDs as shown in Figure 4-21.

On connector P1, Pin 12 is an open collector output for controlling a PZT. If used, the 5880 PZT will match the PZT pattern of the on-board (or 5860) annunciator.

Note: The circuit connected to "Open Collector Output" (last pin on P1) must be current limited so that no more than 100 mA of current is allowed to flow into the open collector transistor.

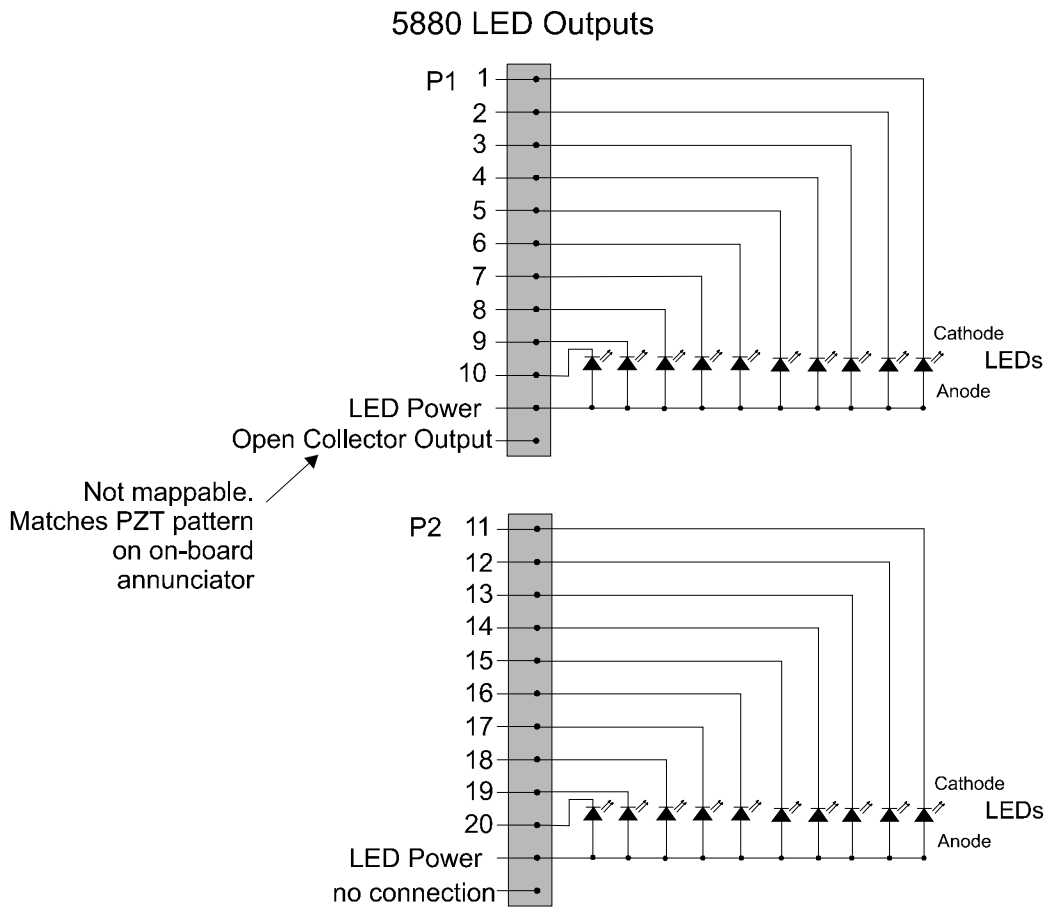

Connectors P3 and P4 wired same as P2.

Figure 4-21 5880 Board Layout

4.7.4 Dry Contact Wiring

The 8 input circuits on the 5880 board are for monitoring switch inputs-any type of switch supported by the control panel can be used with the 5880. For example, you can use a 5880 to monitor pull stations, water flow, tamper, reset, or silence switches.

Wire dry contacts as shown in Figure 4-22. Notice grouping of terminals; power terminals are shared by two inputs.

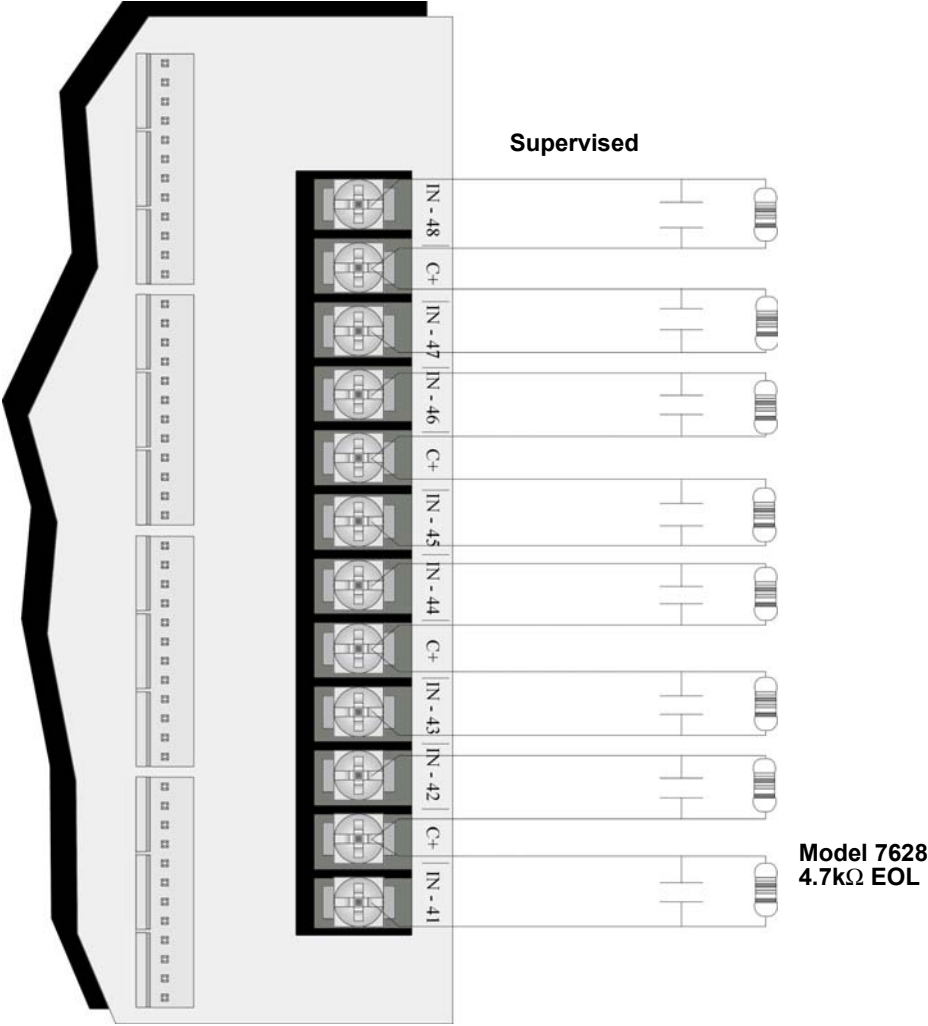

Figure 4-22 Dry Contact Wiring

4.8 5865-3 / 5865-4 LED Annunciator Installation

The 5865-3 and 5865-4 are LED annunciators. The 5865-4 has 30 mappable LEDs, remote silence and reset key switches, and a general system trouble LED. The 5865-3 has 30 mappable LEDs only. These are arranged as 15 pairs of red (typically used for alarm) and yellow (typically used for trouble) LEDs.

Installation of the 5865-3 and 5865-4 is identical. The key switches and the trouble LED follow the behavior of other system annunciators and do not require any installation steps. The following sub-sections describe how to install the 5865-3 and 5865-4 hardware. Refer to Section 6 for programming information.

Note: This manual uses \hat{i} 5865 \hat{i} when referring to aspects of the 5865-3 and 5865-4 that are common to both models.

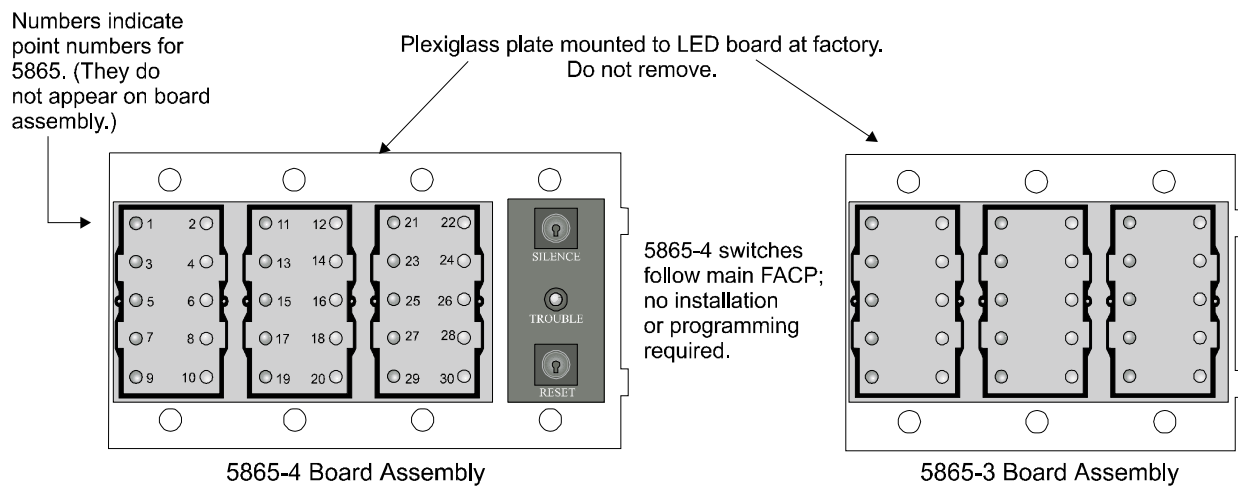

Figure 4-23 5865-3 and 5865-4 Assembly (front view)

4.8.1 FACP Connection

The 5865 connects to the panel via the SBUS. Make connections as shown in Figure 4-24. After the 5865 is connected to the panel, it must be added to the system. This programming step is described in Section 4.9.

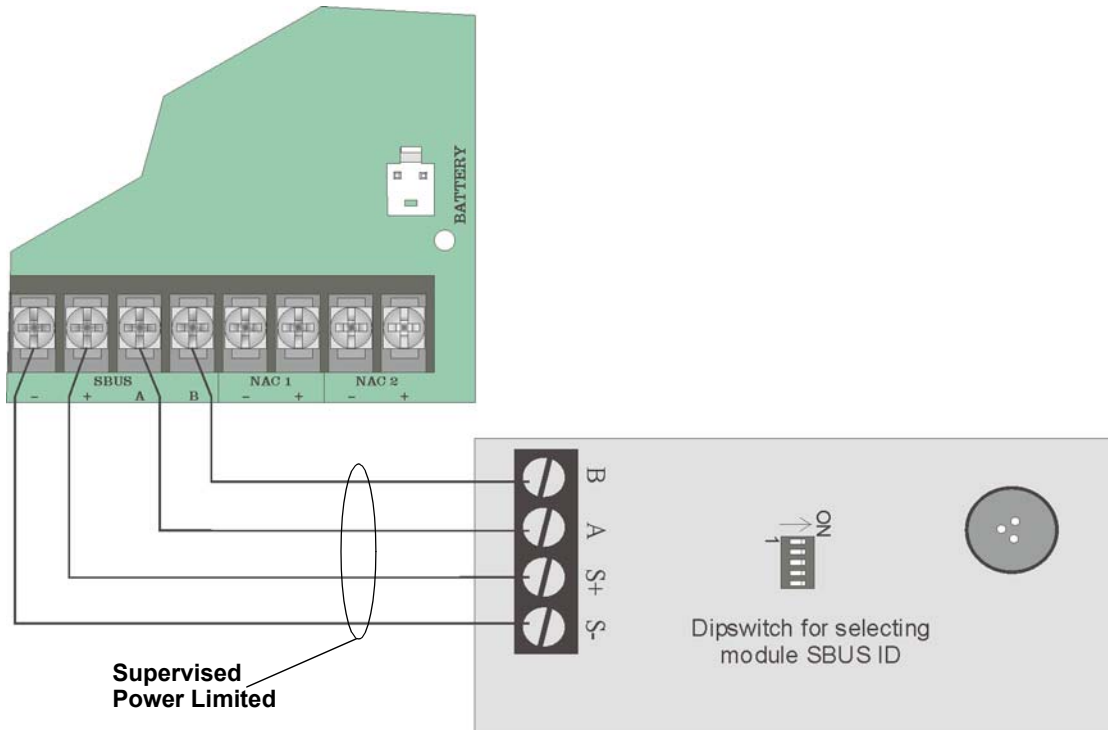

Figure 4-24 5865 Connection to the FACP

4.8.2 5865 Mounting

Mount the 5865-4 to a standard 4-gang electrical box. Mount the 5865-3 to a standard 3-gang

electrical box. In Figure 4-25, the 5865-4 attached to a 4-gang box is used as an example.

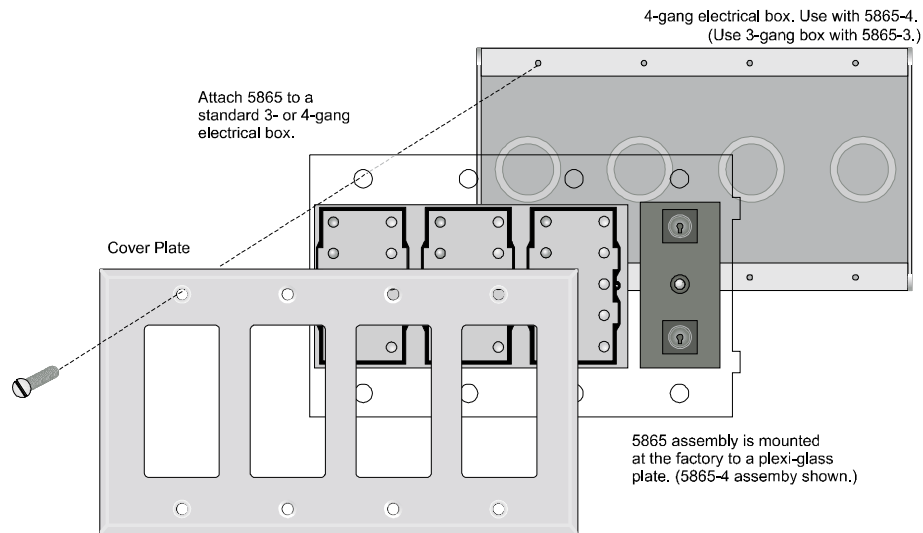

Figure 4-25 5865 Mounting Example

The 5865 ships with a set of zone description labels that can be inserted into the 5865 board assembly. These labels can be used in a typewriter or can be written on by hand.

Slide the labels under the plexiglass as shown in Figure 4-26. The LEDs will show through the label when illuminated.

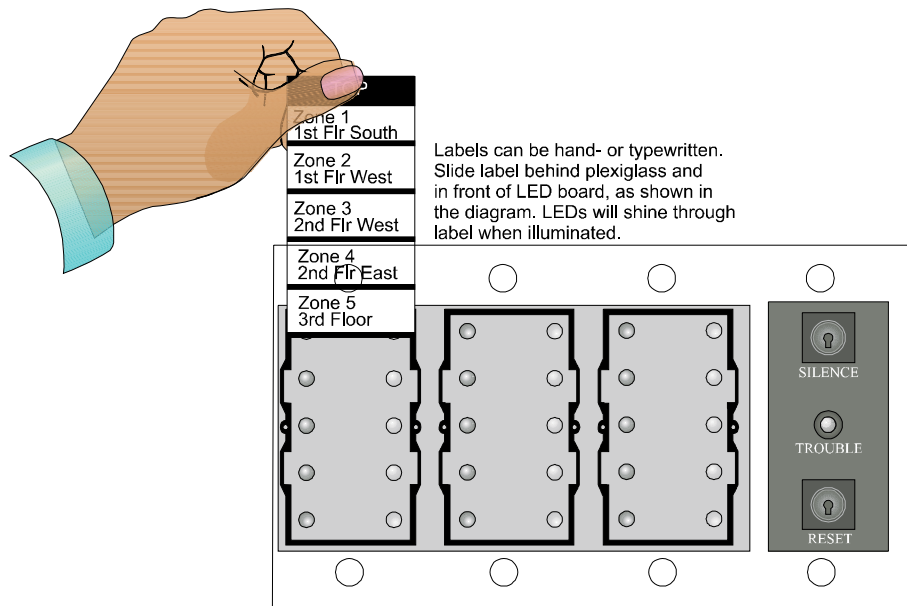

Figure 4-26 Inserting Zone Description Labels

4.9 Configuring Modules

This section describes how to configure any system hardware modules that have been added to the system.

4.9.1 Assigning Module IDs

When installing a hardware module (such as, 5824, 5860, 5496, 5865-3 or 5865-4), you must use the dipswitches on the module to assign an ID# to the module.

Figure 4-27 shows all possible dipswitch positions and their correlation to a numerical ID. For example, to select ID 2, place dipswitch 2 in the up position.

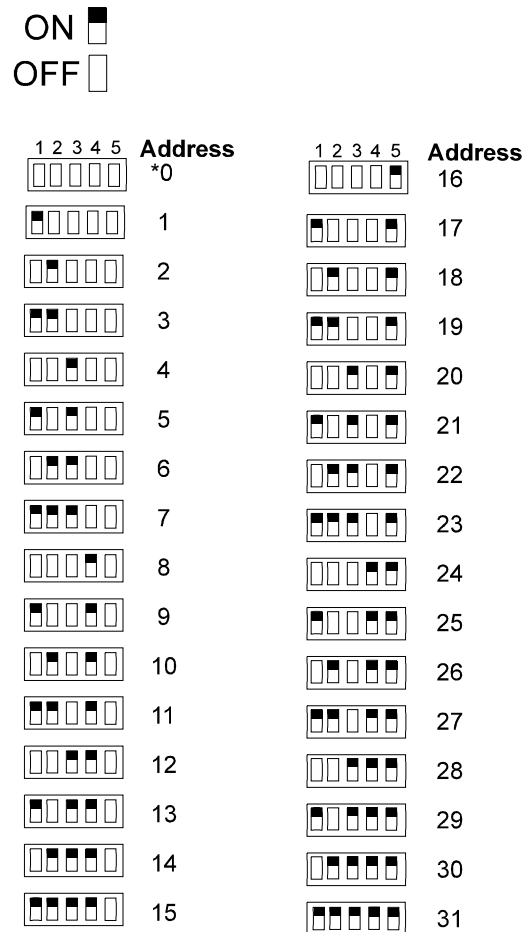

*Note: Address 0 cannot be used.

Figure 4-27 Possible module addresses

Refer to Section 7.1 to edit, add, delete, and view module list.

4.10 Telephone Connection

Connect the telephone lines as shown in Figure 4-28. The Model 7860 phone cord is available from Silent Knight for this purpose.

A number of programmable options are available for customizing telephone lines. These options are described in Section 7.5.

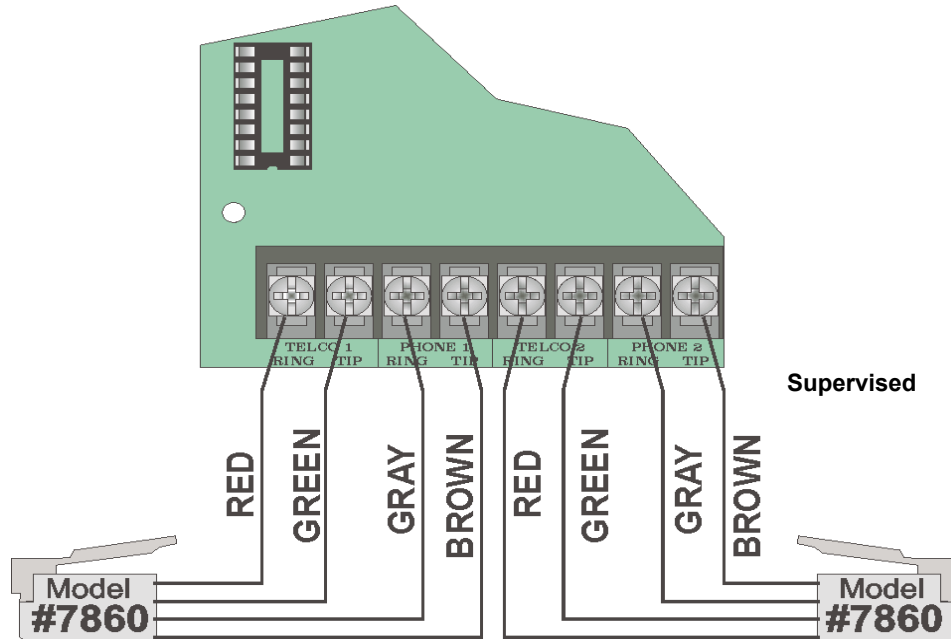

Figure 4-28 Connection of Telephone Lines

4.11 Notification Appliance/Auxiliary Power Circuits

Two outputs are built-in to the 5700 FACP which can be programmed to be used as NACs (Class A or Class B) or as Aux power.

This section of the manual explains how to install conventional notification appliances and how these terminals can be used for auxiliary power.

4.11.1 Conventional Notification Appliance

This sub-section of the manual explains how to install conventional notification appliances for Class A (Style Z) and Class B (Style Y) configurations.

4.11.1.1 Class B Notification Wiring

You must use an appliance from the list of compatible appliances in the Appendix A at the back of this manual.

To install a Class B notification appliance circuit:

1. Wire Class B Notification appliances as shown in Figure 4-29.
2. Configure the circuit through programming (see Section 7.4).

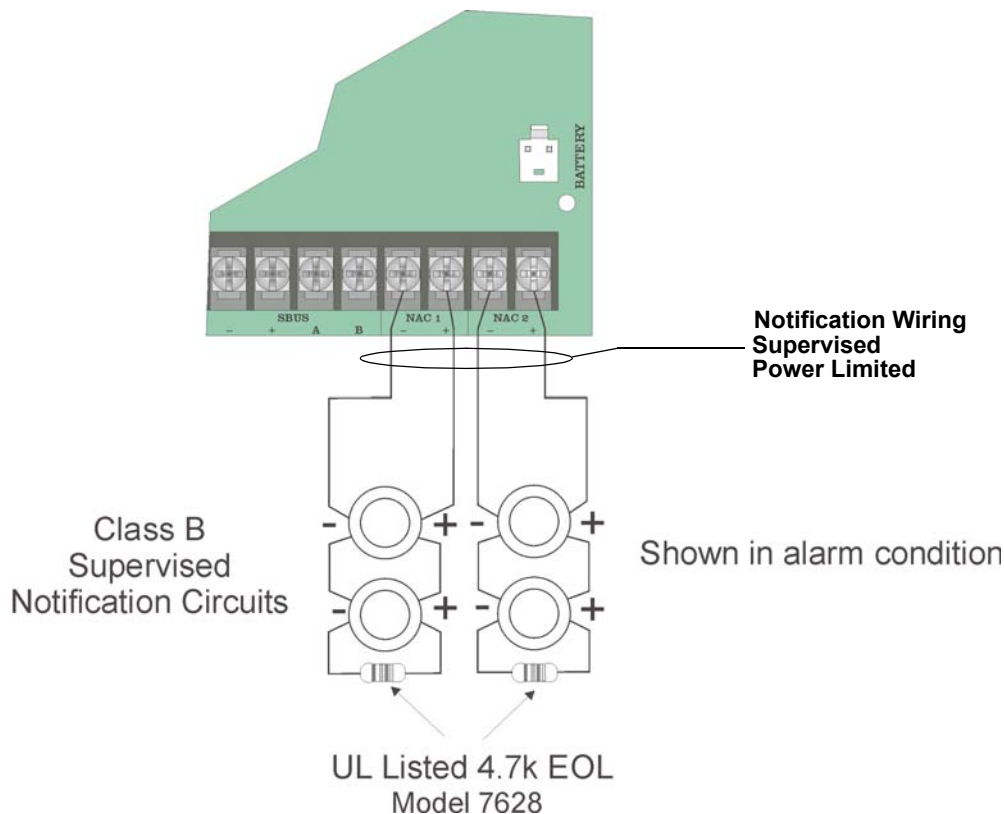

Figure 4-29 Class B Notification Appliance Circuit Wiring

4.11.1.2 Class A Notification Wiring

You must use an appliance from the list of compatible appliances in the Appendix at the back

of this manual.

To install a Class A notification appliance circuit:

1. Wire the Class A notification appliances as shown in Figure 4-30.
2. Configure the circuit for Class A in programming (see Section 7.4).

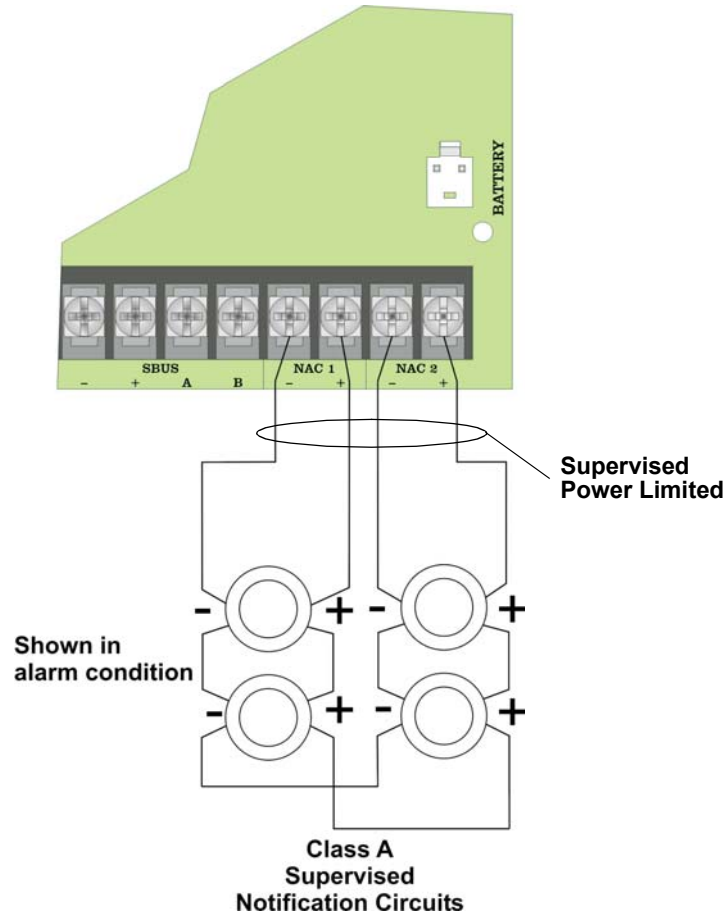

Figure 4-30 Class A Notification Appliance Circuit Configuration

4.11.2 Auxiliary Power Installation

NAC Circuits 1 and 2 on the control panel can be used as auxiliary power circuits. The three types of auxiliary power available are:

- i Door Holder (see section 4.11.2.1)
- ii Constant (see section 4.11.2.2)
- iii Resettable Power (see section 4.11.2.3)

Auxiliary power circuits are power limited. Each circuit can source up to 2.5A (total current for system must not exceed 2.5A).

To install an auxiliary power circuit:

1. Wire the NAC circuit(s) that will be used for auxiliary power. See Figure 3-2 for location of NAC circuits.
2. Configure the auxiliary power output through programming (see section 7.4).

4.11.2.1 Door Holder Power

Door holder power is intended for fire door applications. When there are no alarms in the system and the panel has AC power, door holder circuits have 24-volt power present at their terminals. Any alarm will cause power to disconnect. Power will be re-applied when the system is reset. If AC power is off for more than 15 seconds, the auxiliary door holder power will be disconnected to conserve the battery backup. When AC power is restored, power is immediately restored to the door holder circuits.

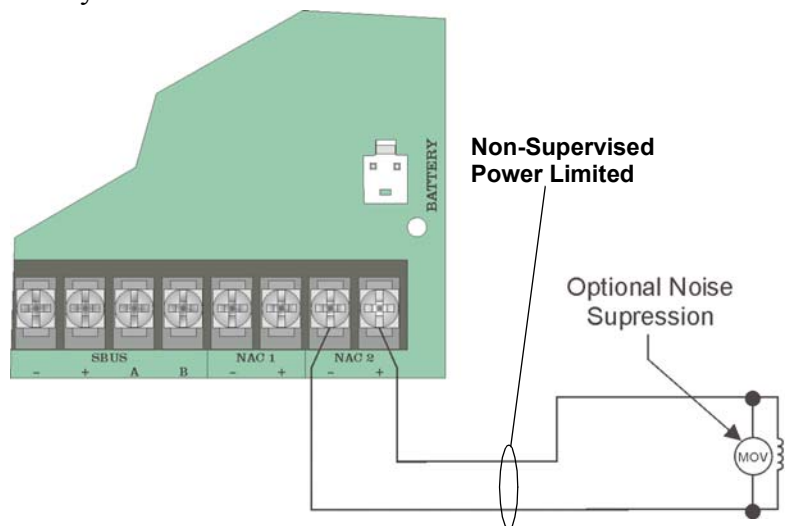

Figure 4-31 Example of an Auxiliary Power For Door Holder

Note: Figure 4-31 uses UL listed door holder Model 1400 from Door Control International as an example.

4.11.2.2 Constant Power

Use constant power for applications that require a constant auxiliary power source. Power is always present at Constant circuits.

4.11.2.3 Resettable Power

Resettable power is typically used to power beam detectors, flame detectors and conventional 4-wire smoke detectors. For circuits selected as Resettable, 24-volt power is always present at the terminals unless a system reset occurs. If a system reset occurs, power is disconnected from the terminals for 30 seconds, then re-applied.

4.12 On-Board Relays (Conventional)

The control panel has two built-in programmable relays and a built-in trouble relay. All relays are Form C rated at 2.5 A @ 24 VDC Resistive.

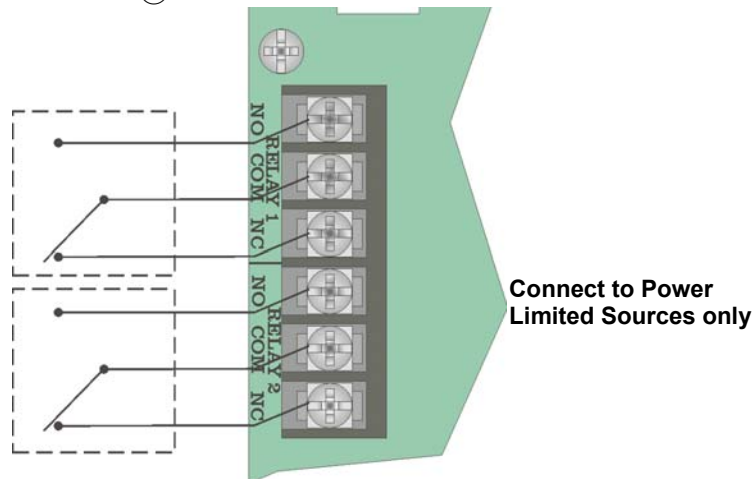

Figure 4-32 Location of Conventional Relay Circuits

Note: The N.C. contact is the relay contact that is closed when the panel has power and there are no alarm or trouble conditions.

4.12.1 Trouble Relay

The control panel has a dedicated Form C trouble relay built into terminals labeled TROUBLE. The relay provides a normally open and a normally closed contact. The trouble relay will deactivate under any trouble condition. Form C rated at 2.5 A @ 24 VDC Resistive.

4.12.2 Programmable Relays

The control panel has two Form C programmable relays built into terminals labeled RELAY 1 or RELAY 2. Each relay provides a normally open and a normally closed contact.

To install one or two programmable relays, follow these steps.

1. Wire Relay 1 and/or Relay 2 as needed for your application. See Figure 4-32 for the location of the relay terminals.

2. Configure the relay through programming (see section 7.4).

4.13 Remote Station Applications

4.13.1 Keltron Model 3158 Installation

The control panel is compatible with Keltron Model 3158, used for direct connection to a Keltron receiver. The 3158 reports alarms, supervisories, and troubles.

The steps for connecting the 3158 to the control panel. Refer to the 3158 installation instructions for complete information.

1. Wire the 3158 to the control panel as shown in the connection list and Figure 4-33.
2. Wire the 3158 within 20 feet of the control panel. Wiring must be enclosed in conduit.
3. Program control panel Relay 2 for alarm.
4. Program NAC circuit 2 for alarm.
5. Program NAC circuit 1 for supervisory non latching.

Note: NACs must be programmed for continuous and non-silencing.

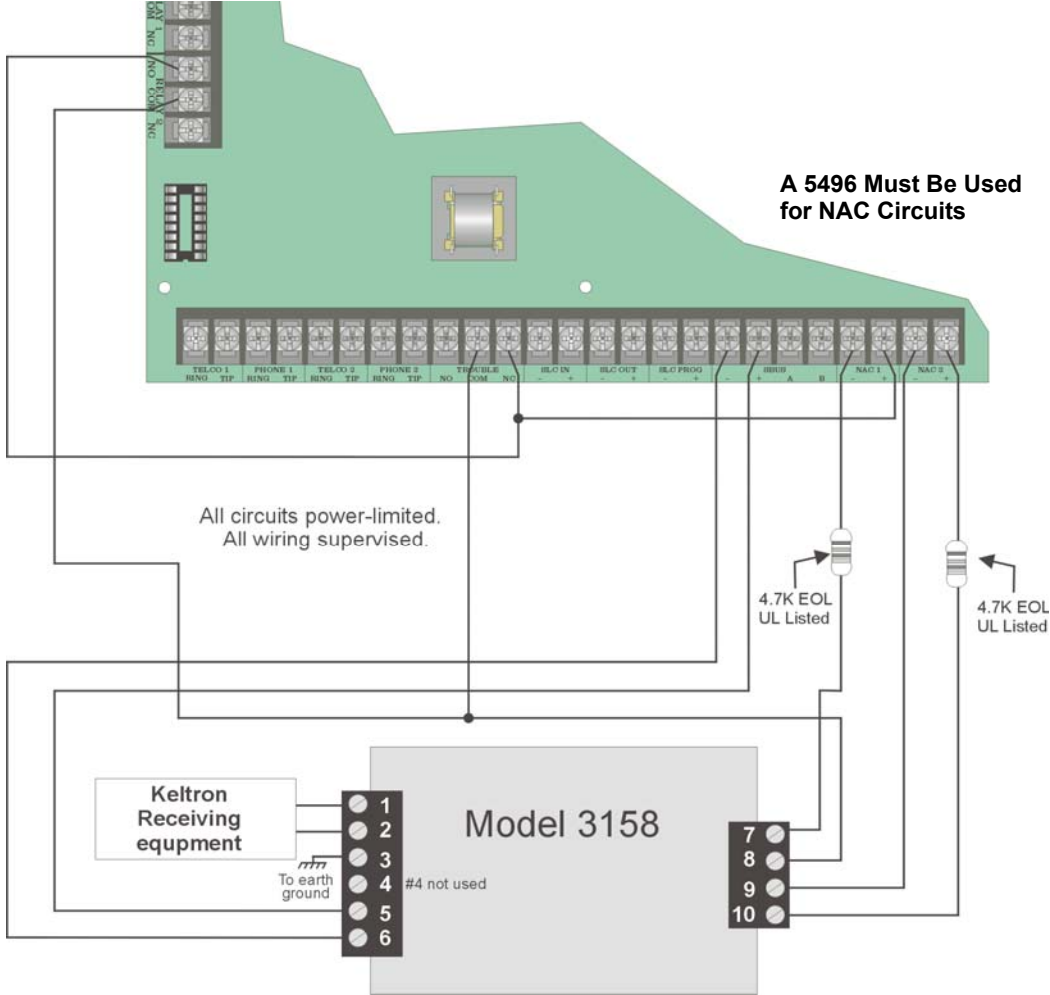

Figure 4-33 Keltron 3158 Connection to Control Panel

4.13.2 City Box Connection Using the 5220 Module

This section describes how to connect the control panel to a municipal fire alarm box or a city box as required by NFPA 72 Auxiliary Protected Fire Alarm systems for fire alarm service. The city (master) box is an enclosure that contains a manually operated transmitter used to send an alarm to the municipal communication center which houses the central operating part of the fire alarm system.

City Box Standby Current: 0 (Notification supervision current accounted for in control panel draw.)

Alarm Current: 1 Amp for 1 second

The maximum coil and wire resistance (combined) must not exceed 30 ohms.

To install the 5220 for city box connection:

1. Use one of the knockouts on the right side of the control panel to connect the 5220 using a short piece of conduit (must not exceed 20 feet in length).
2. Wire the 5220 to the control panel as shown in Figure 4-34. This drawing also shows how to connect the city box coil to terminals 3 and 4 on the 5220. Do not install an EOL resistor in the terminals of the NAC circuit used for this application.
3. Connect earth ground wire to the 5220 chassis with mounting screw.
4. Program the NAC circuit used as a continuous and non-silencing. Refer to Section 7.4.1 for zone grouping and mapping.

It is not possible to reset the remote indication until you clear the condition and reset the

control panel.

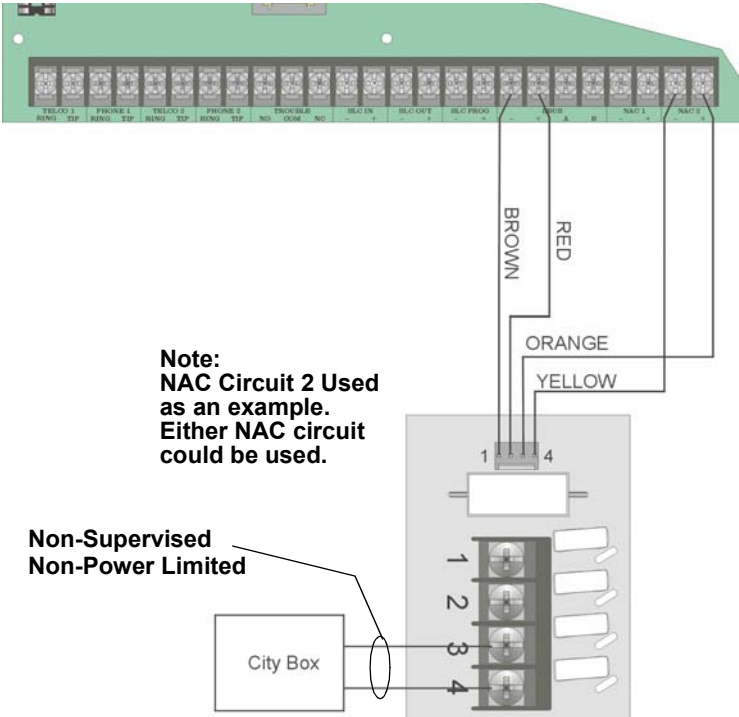

Figure 4-34 City Box Connection

4.13.3 NFPA 72 Polarity Reversal

4.13.3.1 Using the 5220 Module

When the 5220 is wired and programmed for polarity reversal, it reports alarm and trouble events to a remote site. Alarms will override trouble conditions and it will not be possible to reset the remote indicator until the condition is cleared and the control panel is reset.

If an alarm condition occurs, the alarm relay will close, overriding the trouble condition.

Standby Current: 100 mA

Alarm: 100 mA

To install the 5220 for polarity reversal, follow the steps below:

1. Locate the knockout on the right side of the control panel cabinet to connect the 5220 using a short piece of conduit (must not exceed 20 feet in length).
2. Wire the 5220 to the control panel using the four-wire pigtail provided as shown in Figure 4-35. This diagram also shows how to connect the 5220 to the remote indicator. Do not install an EOL resistor in the terminals of the NAC circuit used for this application.
3. Connect earth ground wire to the 5220 chassis with mounting screw.
4. Program the NAC circuit used as continuous and non-silencing. Refer to Section 7.4.1 for zone grouping and mapping.

- 5. If necessary, adjust loop current using the potentiometer (R10) on the 5220 board . Normal loop current is 2-to-8 mA with a 1k ohm remote station receiving unit. Maximum loop resistance is 3k ohm.

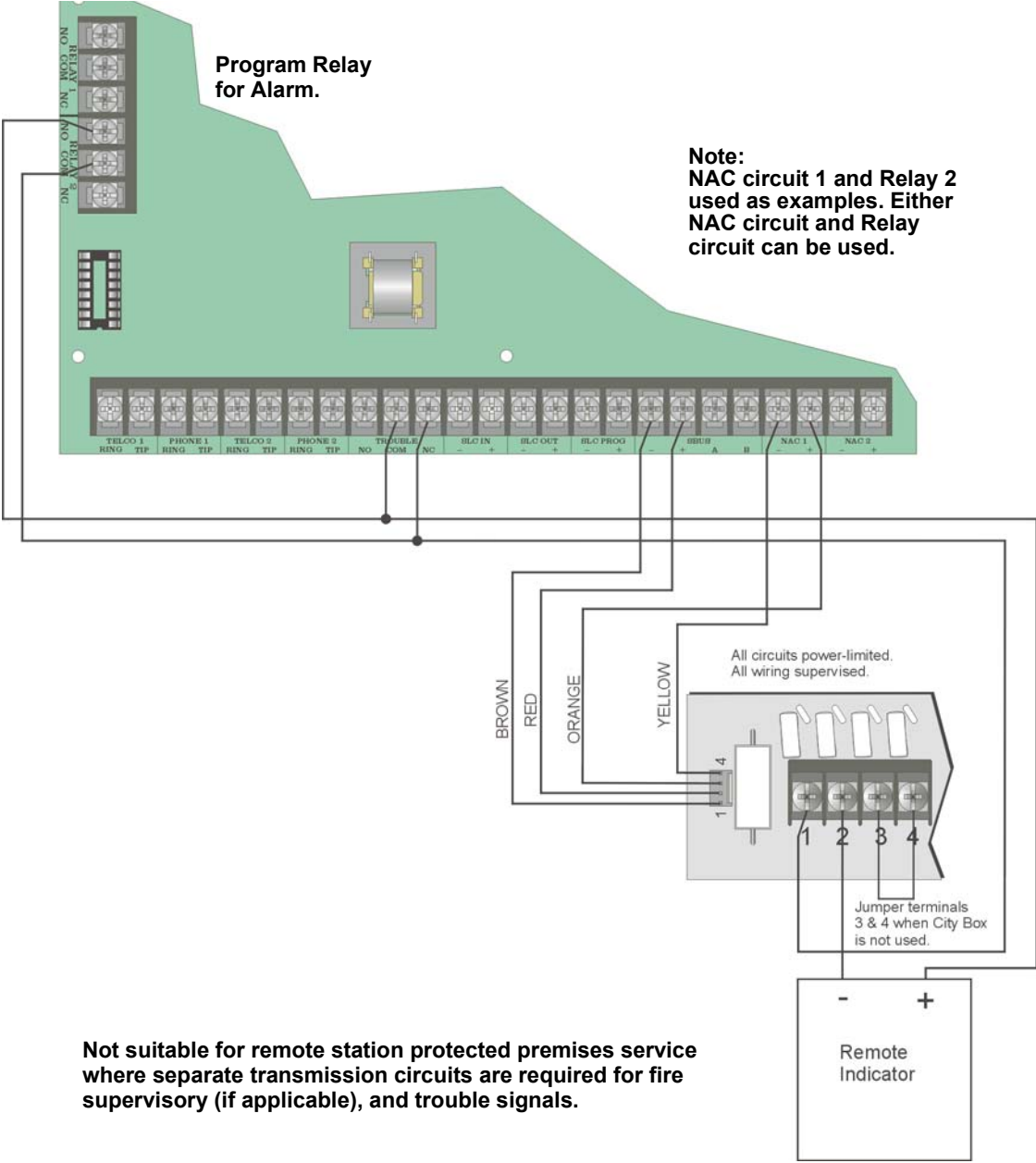

Not suitable for remote station protected premises service where separate transmission circuits are required for fire supervisory (if applicable), and trouble signals.

Figure 4-35 Polarity Reversal Connection Using the 5220 Module

4.13.4 Using the SD500-ARM Addressable Relay Module

When the SD500-ARM is wired for polarity reversal, it reports alarm and trouble events to a remote site. Alarms will override trouble conditions and it will not be possible to reset the remote indicator until the condition is cleared and the control panel is reset.

Relay 2 must be programmed for Alarm (default).

Note: If you need to transmit supervisories or trouble conditions, additional SD500-ARM modules must be added. Use relay 1 to transmit supervisory conditions. Use the trouble relay to transmit trouble conditions.

Wire the SD500-ARM as shown in Figure 4-36.

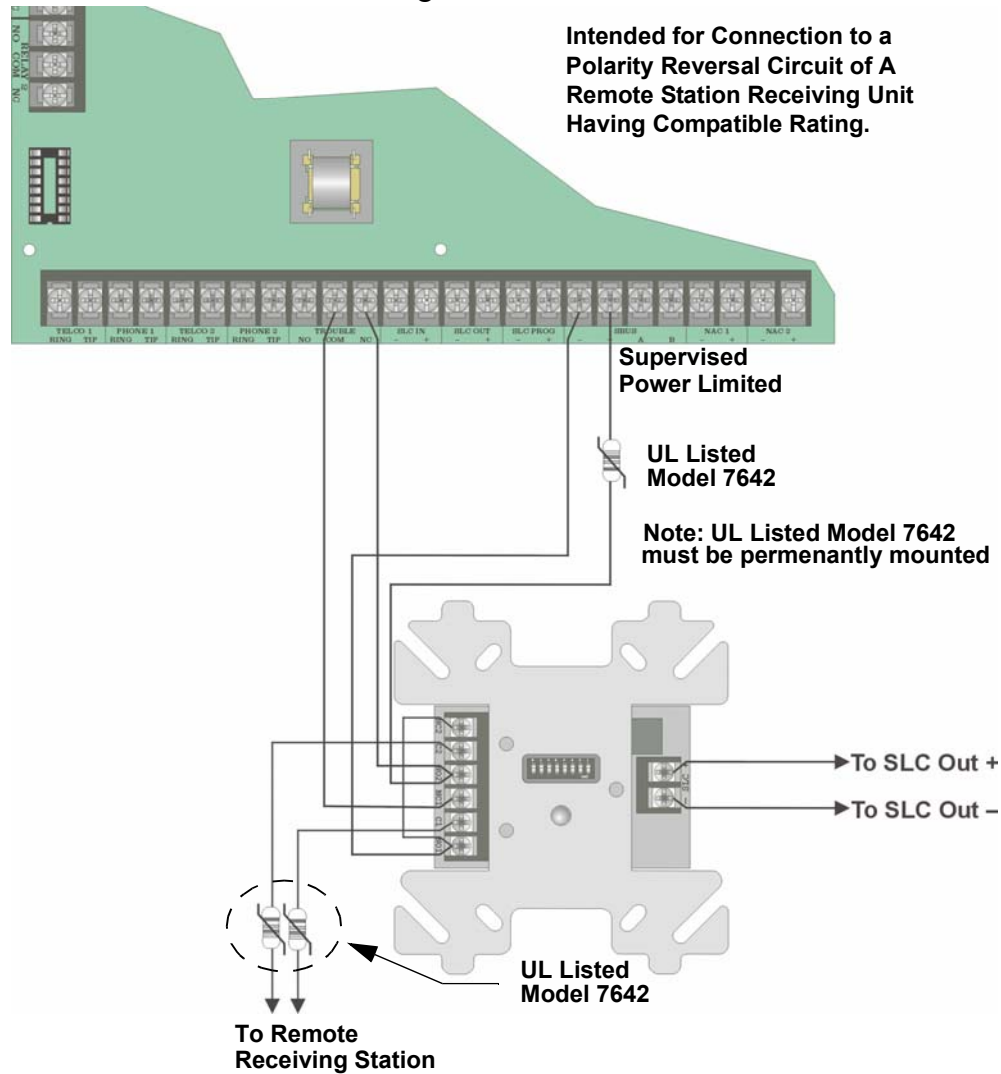

Figure 4-36 Polarity Reversal Connection Using the SD500-ARM Module

4.13.5 Using a MR-201/T Control Relay From Air Products

When the MR-201/T control relay is wired for polarity reversal, it reports alarm and trouble events to a remote site. Alarms will override trouble conditions and it will not be possible to reset the remote indicator until the condition is cleared and the control panel is reset.

If an alarm condition occurs, the alarm relay will close, overriding the trouble condition.

Current: 15 mA max.
 Operating Voltage: 24 VDC nominal
 Resistance: 4 K Ω

To install the MR-201/T for polarity reversal, follow the steps below:

1. Wire the MR-201/T as shown in Figure 4-37.

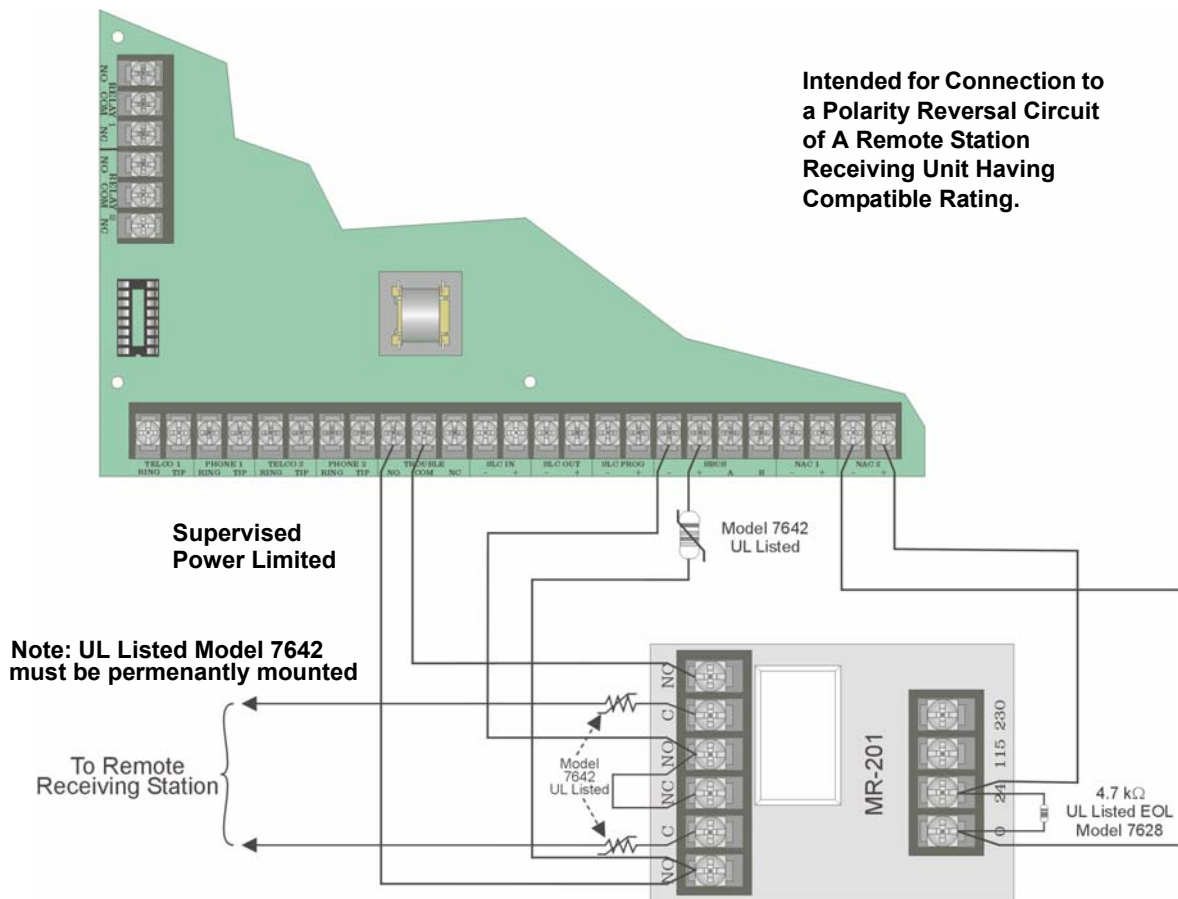

Figure 4-37 Polarity Reversal Connection Using the MR-201/T Relay

2. Program the NAC circuit for non silence NAC circuit (see Section 7.4).

Note: If you need to transmit supervisories or trouble conditions, additional relay modules must be added. Use relay 1 to transmit supervisory conditions. Use the trouble relay to transmit trouble conditions.

Section 5

SLC Device Installation

Caution

To avoid the risk of electrical shock and damage to the unit, power should be OFF at the control panel while installing or servicing.

5.1 Types of SLC Devices

The following types of SLC devices can be used with the system.

- ï **Model SD500-AIM** Input Module (switch input), standard size, dipswitch configurable
- ï **Model SD500-MIM** Mini Input Monitor Module (switch input), small size, dipswitch configurable. Fits in single-gang box with manual pull station switch.
- ï **Model SD500ARM** Addressable Relay Module, dipswitch configurable
- ï **Model SD500-LIM**. SLC short circuit isolator module. Fits in a double gang box. Refer to *SD500-LIM Installation Instructions P/N 151125*.
- ï **Model SD505-6IB**. Short circuit isolator base for SD505-AHS, SD505-AIS, and SD505-APS SLC devices. Refer to *SD505-6IB Installation Instructions P/N 151175*.
- ï **Model SD505-AHS** Heat Sensor
- ï **Model SD505-APS** Photoelectric Smoke Detector
- ï **Model SD505-ADH** Duct Housing (used with SD505-AIS or SD505-APS smoke detectors)
- ï **Model SD505-ADHR** Duct Detector Housing With Relay (used with SD505-AIS or SD505-APS smoke detectors). Refer to *SD505-ADHR Installation Instructions P/N 151126*.
- ï **Model SD505-DTS** Remote Test Switch & LED indicator for the SD505-ADHR.
- ï **Model SD500-PS/PSDA** Single or Dual action Addressable pull station. Refer to *SD500-PS/PSDA Installation Instructions P/N 151177*.

5.2 Maximum Number of Devices

A total of 50 addressable devices can be used with the system.

5.3 Wiring Requirements for SLC Devices

The following information applies to all SLC devices. Refer to the section that describes the type of device you are installing for details.

5.3.1 Wiring SLC devices in Style 4 (Class B)

No special wire is required for addressable loops. The wire can be untwisted, unshielded, solid or stranded as long as it meets the National Electric Code 760-51 requirements for power limited fire protective signaling cables.

Maximum wiring resistance is 50 ohms.

Maximum loop length depends on the wire gauge.

Wire Gauge	Max. Distance
22 AWG	1500 feet
18 AWG	3900 feet
16 AWG	6200 feet
14 AWG	10,000 feet

Figure 5-1 and Figure 5-2 show how wire length is determined for out-and-back tap and T-tap style wiring.

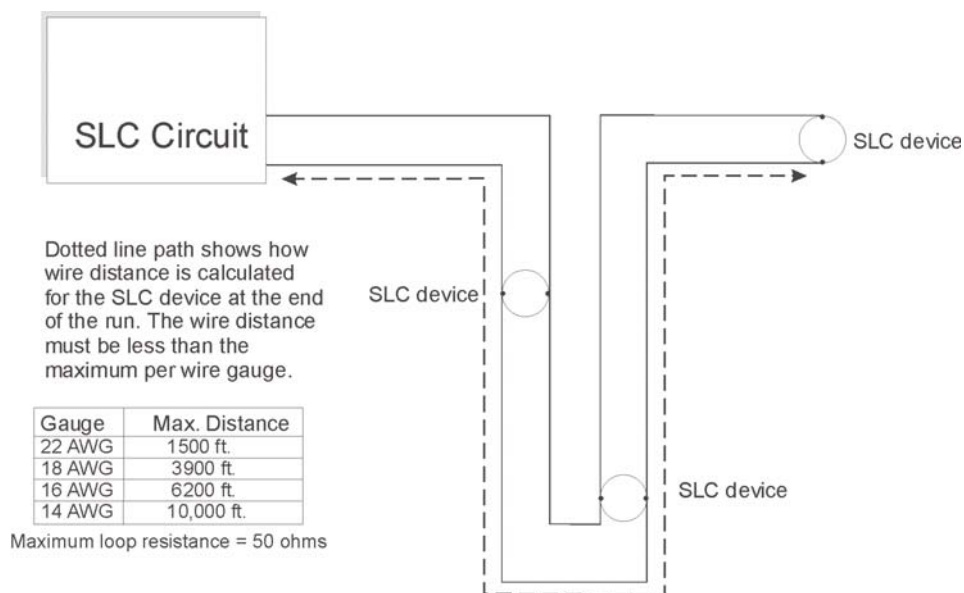

Figure 5-1 Calculating wire run length for a simple out and back

When using T-taps, the total length of all taps and the main bus must not exceed 40,000 feet. This requirement must be met in addition to the maximum distance requirements for the various wire gauges.

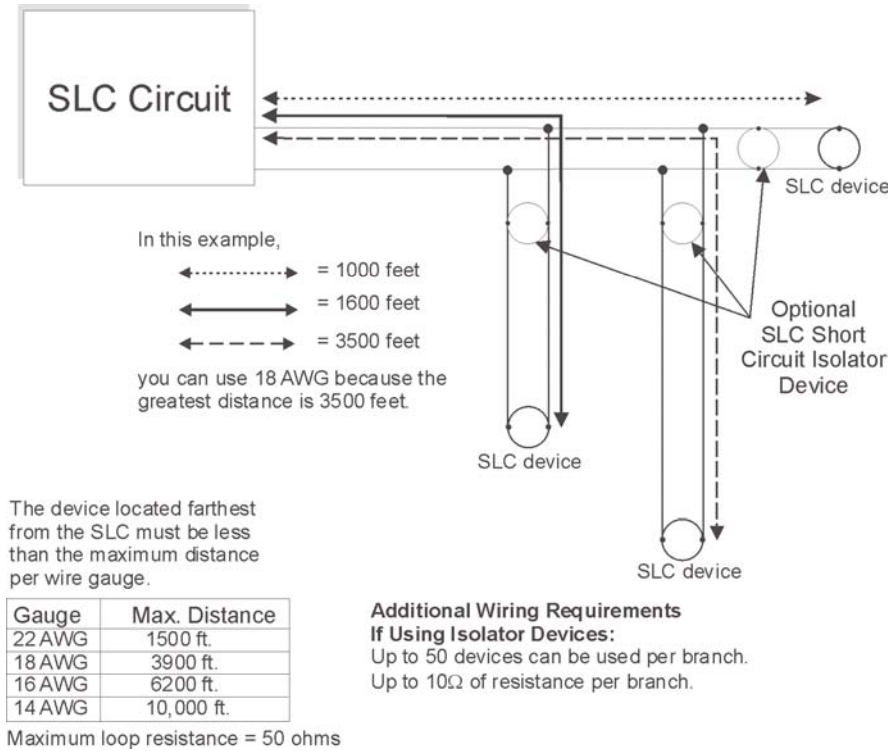

Figure 5-2 Calculating Wire Run Length for a T-tap

5.3.2 Wiring SLC Devices in Style 6 & 7 (Class A)

Figure 5-3 illustrates how to wire the SLC loop for Style 7 Class A installations.

Note: Figure 5-3 illustrates Style 7 configurations, Style 6 does not use short circuit isolator devices.

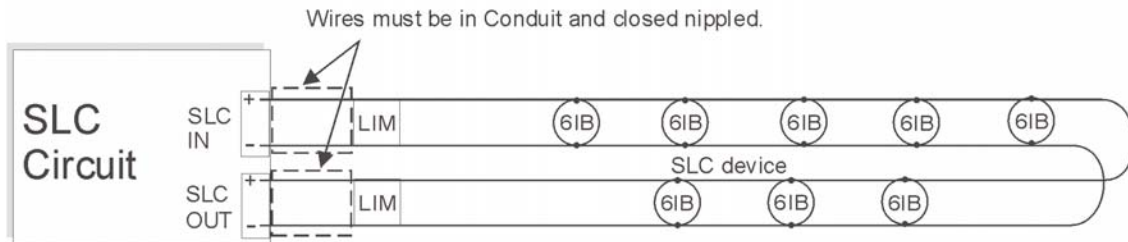
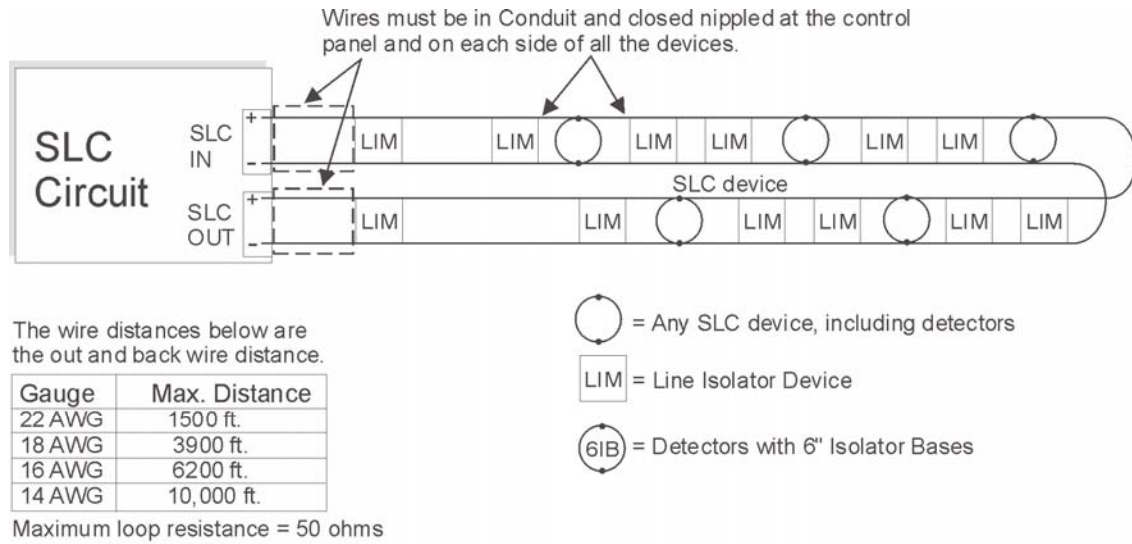

Figure 5-3 Class A SLC Configuration

Note: No t-taps allowed on class A SLC loops.

5.4 Heat and Smoke Detector Installation

The information in this section applies to the following models: SD505-AHS Heat Detector, and SD505-APS Photoelectric Smoke Detector.

See also Section 5.9 for information on how to address the detectors.

5.4.1 Wiring

1. Wire device bases as shown in Figure 5-4.
2. Set the address for each device as described in Section 5.9.
3. Connect the device as shown in Figure 5-4.

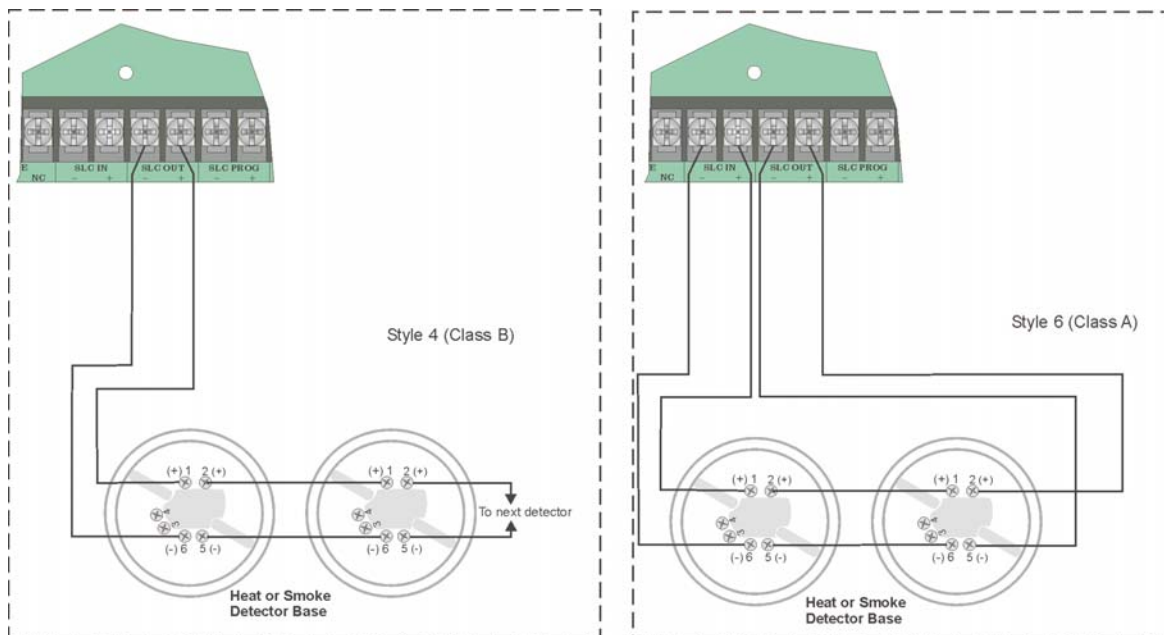

Figure 5-4 Heat or Smoke Detector Connection to the FACP

5.5 Duct Detector Installation

Figure 5-5 shows the layout of the SD505-ADH duct housing with a detector base in place, including location of the terminals for connection to the FACP. Figure 5-6 shows wiring in detail.

Address the detector head before attaching it to the base. This procedure is explained in Section 5.9.

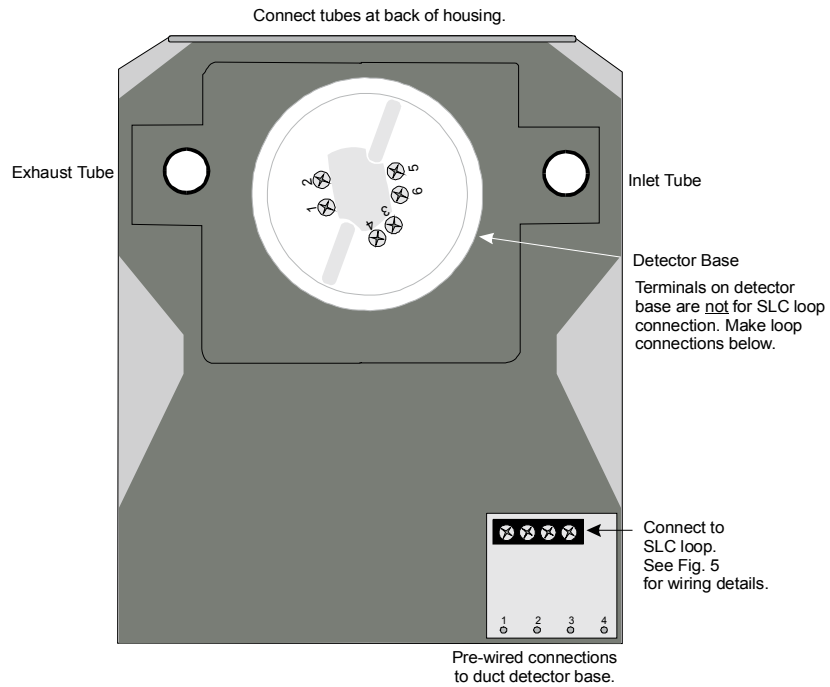

Figure 5-5 Model SD505-ADH Internal View Showing Connector Locations

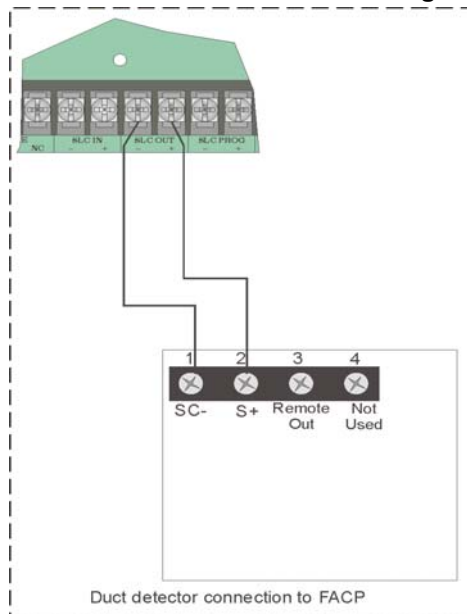

Figure 5-6 Duct Detector Connection to the Control Panel

5.6 Input Monitor Module (SD500-AIM)

Wire and mount the SD500-AIM full-size input module as described in this section (see Figure 5-7 and Figure 5-8). See Section 5.9.2 for information on how to use the on-board dipswitch to select an address for the module.

Wire the monitor modules to the SLC as shown in Figure 5-7.

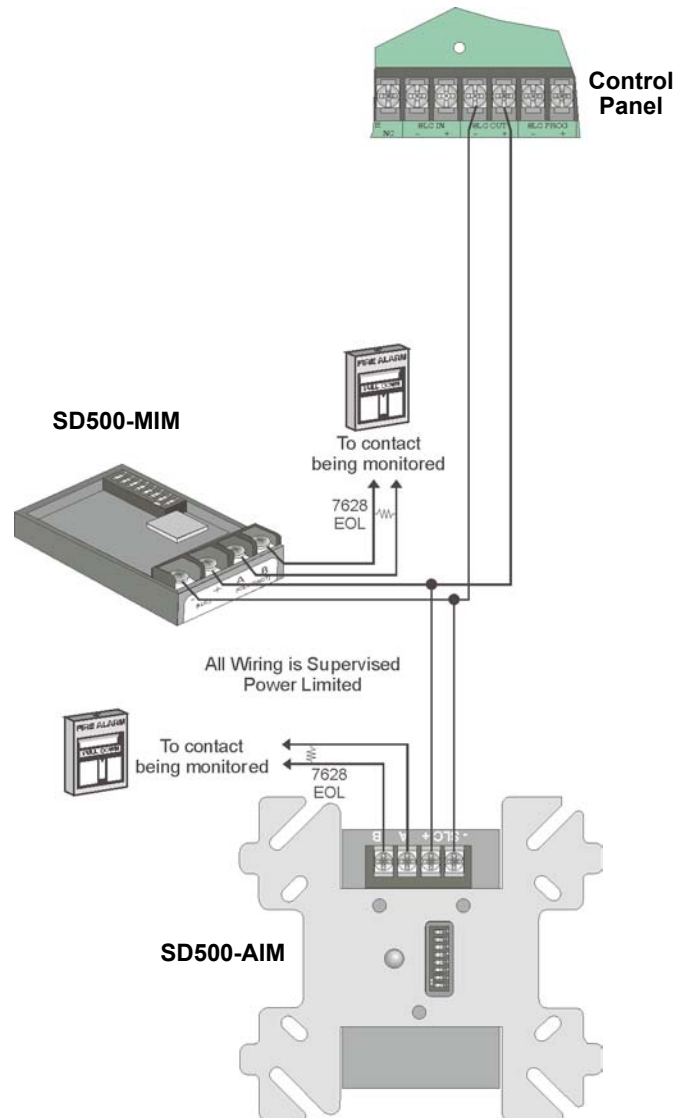

Figure 5-7 SD500-AIM/MIM Input Module Connection to the FACP (Class B)

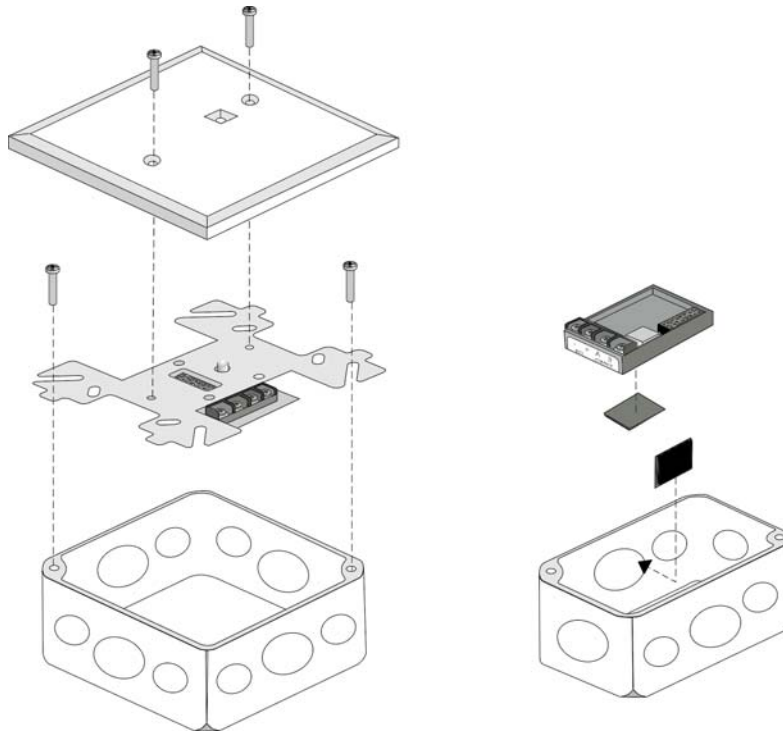

Figure 5-8 SD500-AIM/MIM Input Module Mounting Example

5.7 Mini Input Module (SD500-MIM)

Wire the SD500-MIM Mini Input Module as shown in this section (see Figure 5-7 and Figure 5-8). The SD500-MIM fits inside a single-gang electrical box. See Section 5.9.2 for information on using the on-board dipswitch to select an address for the module.

5.8 Relay Module Installation

The information in this section applies to Model SD500-ARM Relay Modules. See Section 5.9.2 for information on how to use the on-board dipswitch to select an address for the module.

5.8.1 Electrical Specifications

The following is electrical rating information for SD500-ARM relay modules.

Relay Ratings

30 VDC @ 2.0 A Resistive

30 VDC @ 1.0 A Inductive (.6PF)

30 VDC @ 0.6 A (0.35PF) Pilot Dutyó Light duty low voltage S.W.

120 VAC @ 0.6 A (0.35PF) Pilot Duty

Connect to power limited sources only.

Note: PF = Power Factor.

5.8.2 Wiring

Wire relay modules to the panel or to the SLC as shown in Figure 5-9.

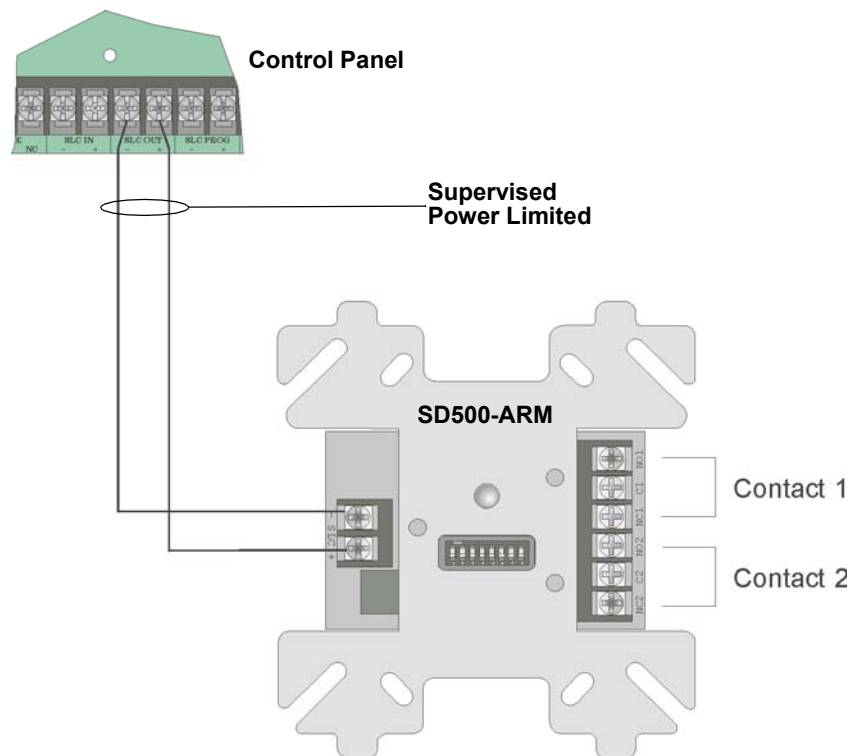

Figure 5-9 Relay Module Connection to the FACP (Class B)

5.9 SLC Device Addressing

5.9.1 EEPROM Addressing

Select addresses for the following models through software as described here:

- i Model SD505-AHS Heat Detector
- i Model SD505-APS Photoelectric Smoke Detector

You must use the Installer Code to perform this task. Here are the steps.

1. Connect a detector base temporarily to the programming terminals as shown in Figure 5-10. (You can use the same base for each detector.)

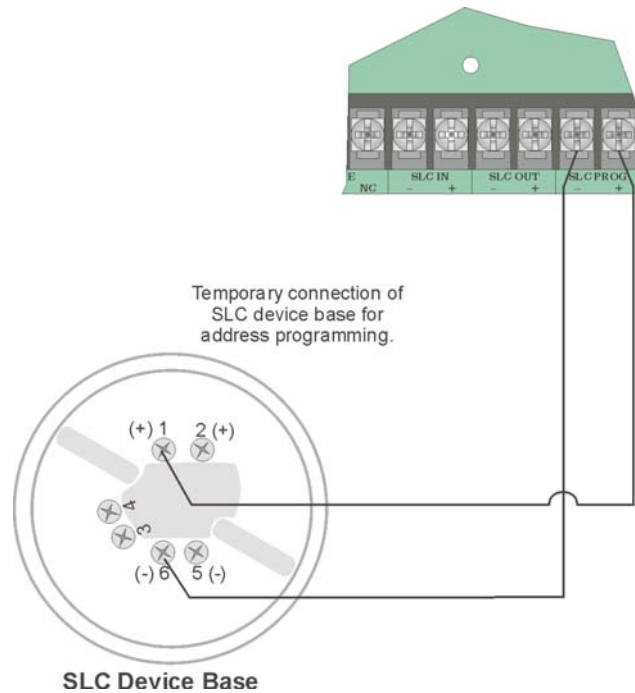



Figure 5-10 Temporary of Detector Base to Panel for Addressing

2. Enter the Installer code and Press .
3. Select for Point Functions.
4. Select for Set SLC Dev Addr.
5. Select 'Yes' by pressing the up arrow, then press . (The panel will go into trouble at this point. You can use the key to stop the PZT. The trouble will clear automatically when the panel reinitializes when you finish programming.)

6. When the wait message clears, the following options display:
 - 1 for Read Address. Use to read (or check) a single detector's address.
 - 2 for Write Address. Use to program a single detector's address.
 - 3 for Seq. Programming. Use to program more than one detector in sequential order.
7. If you are changing addresses, write the programmed address on the back of the device.
8. To exit press  left arrow until fully exited.

5.9.2 Dipswitch Addressing

Input and relay module addresses are set using the dipswitch that appears on the module board. The chart below shows the available addresses. For example, to select address 3, place DIP switches 1 and 2 in the up position. The range of valid addresses is 1-50 (0 is an invalid address).

ON 
 OFF  Note: Dipswitch position 8 must always be OFF.

1	2	3	4	5	6	7	8	Address	1	2	3	4	5	6	7	8	Address
								1									26
								2									27
								3									28
								4									29
								5									30
								6									31
								7									32
								8									33
								9									34
								10									35
								11									36
								12									37
								13									38
								14									39
								15									40
								16									41
								17									42
								18									43
								19									44
								20									45
								21									46
								22									47
								23									48
								24									49
								25									50

Figure 5-11 SLC Device Addressing Using Dipswitches

Section 6

Programming Overview

This section of the manual is intended to give you an overview of the programming process. Please read this section of the manual carefully, especially if you are programming the control panel for the first time.

The JumpStart feature automates many programming tasks and selects default options for the system. You will run JumpStart at least once when you are installing the system. See Section 6.1 for details. After you run JumpStart, you may need to do some additional programming depending on your installation. Section 7 of this manual covers manual programmable options in detail.

Programming the panel can be thought of as a three part process. You must program:

- i System options. These are options that affect general operation of the panel (see Section 7.5 for details).
- ii Options for input points and zones. These are primarily options that control detection behavior of devices (see Section 7.4 for details).
- iii Options for output points and groups. This includes selecting characteristics for output groups and mapping output circuits to output groups (see Section 7.4 for details).

6.1 JumpStart Autoprogramming

The JumpStart feature allows for faster system setup. When you run JumpStart (immediately after addressing SLC devices), the system scans devices on all SLC loops and determines device type (for example, photoelectric smoke detector or heat sensor) and selects some system options based on the device type. This saves the installer from having to program options for each device. Depending on the application, the installer may need to make some changes after JumpStart completes.

See Section 6.1.3 for complete details about running JumpStart.

IMPORTANT!

JumpStart is intended to be run one time only, immediately after SLC devices have been addressed and connected. JumpStart will reset all manually programmed options to default settings. Do not run JumpStart after you have configured the system.

6.1.1 Input Points

JumpStart will determine the number and type of input points (detectors or contact monitor modules) on each SLC loop. JumpStart assigns the correct detector type (heat, or photoelectric), so the installer does not need to edit device type for detectors. Any contact monitor modules on the system will be assigned type "Manual Pull." The installer will need to manually change the switch type if manual pull is not correct.

JumpStart creates one zone (Zone 1) and assigns all input points to Zone 1. Zone 1 is mapped to Output Group 1. After JumpStart completes, you can re-map to configure a multiple zone/output group system (see Section 7.2.1.3). For a general explanation of mapping, see Section 6.2.

6.1.2 Output Points

JumpStart creates three output groups and assigns output circuits as follows:

Circuits 1-2:

Configured as Notification and assigned to Group 1. JumpStart automatically programs Zone 1 to activate Group 1 using constant on output.

Circuit 3 (Relay 1):

Assigned to Group 124. JumpStart automatically programs Zone 1 to activate Group 124 using constant on output when a supervisory condition occurs.

Circuit 4 (Relay 2):

Assigned to Group 125. JumpStart automatically programs Zone 1 to activate Group 125 using constant on output when an alarm occurs.

Addressable output points (Relay modules):

All addressable relay devices will be configured as "Output Pt" (general purpose output point) and assigned to Group 1.



Note: Relay output is constant even if the zone activating the relay is programmed with an output pattern.

6.1.3 Running JumpStart

Run JumpStart immediately after you have addressed and connected all input devices (detectors, pull stations, and so on) and output devices (notification appliances, relays, and so on).

Note: If you need to install a few devices after you have run JumpStart, you can install them manually. Follow instructions in Section 8 for configuration.

To run JumpStart, follow these steps.

1. Press  to view the Main Menu.
2. Select  for Program Menu.
3. From the next menu, select  for JumpStart.

4. The message "WARNING Will reset all system options" displays on the LCD. Select Yes to continue. A series of messages displays for the next several seconds. JumpStart scans the SLC loops for devices. This can take several minutes, depending on the number of devices attached.
5. When the message "Configure System Done" displays on the LCD, press any key to continue.
6. Select one of the following options from the menu that displays.

<p>1 - Review System</p>	<p>Press 1 if you need to review the JumpStart configuration.</p>
<p>2 - Repeat JumpStart</p>	<p>Press 2 if you need to rerun JumpStart for any reason.</p>
<p>3 - Accept Configuration</p>	<ol style="list-style-type: none"> 1. If you are ready to make the JumpStart configuration permanent, select 3. 2. The system will ask you if the installation contains duct detectors. If there are none, select 2 for No and skip to Step 8. If the system contains duct detectors, select 1 for Yes and continue with Step 3. 3. From the list that displays, select the SLC device that contains the duct detectors. 4. The first photoelectric detector on the system will display. Select 1 for DUCT and 2 for NonDUCT. 5. Press ▲ to select the next detector. Select 1 for DUCT and 2 for NonDUCT. Continue until all duct detectors have been selected. (Note: You can move backwards through the list with ▼.) 6. When you reach the last detector on this device, press ◀. 7. The system will ask you if there are more duct detectors in the system. If there are, select 1 for Yes and repeat from Step 3. If there are no more duct detectors, select 2 for No and continue with Step 8. 8. The system will restart in 10 seconds. You can press 1 to restart immediately. Do not select 2 for System Diagnostics. (This feature is for use in testing at the factory.) 9. After the system resets, it will use the new JumpStart configuration.

6.2 Mapping Overview

This section of the manual is an overview of mapping. Details about how to select mapping options appear in the appropriate subsections in Section 7.

Mapping is an important concept with the control panel. In general terms, mapping is assigning or linking events to outputs that should activate when events occur. You do this by assigning input points to input zones, output points to output groups and then linking or mapping zones and output groups.

Figure 6-1 is a brief overview of the concept of mapping. The next several pages of the manual show these subjects in detail.

In its simplest application, mapping is determining which outputs are activated by which inputs.

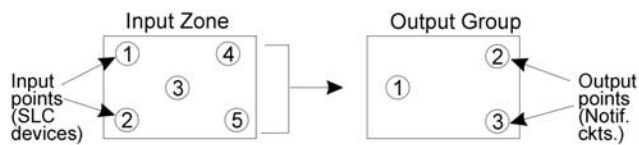

Because the Control Panel programming is so flexible, there are a number of uses for mapping, as shown in the diagram below.

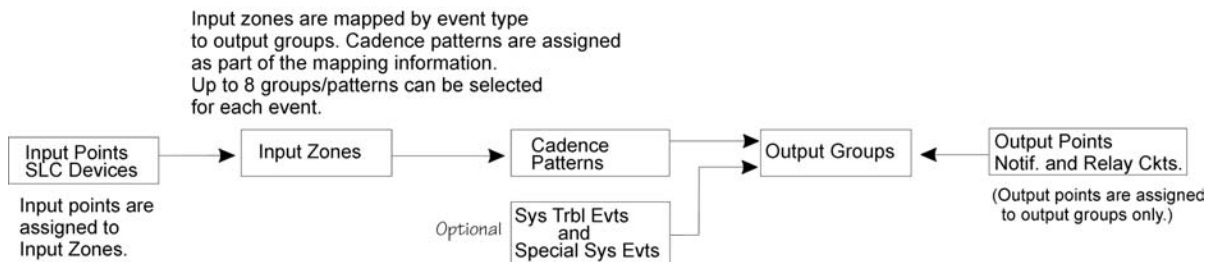

Figure 6-1 Mapping Overview

6.2.1 Input Point Mapping

Input points are assigned to input zones. Any input point can be assigned to any input zone. (Input points can be assigned to one zone only. An input point can be designated as "Unused," which means it has not been assigned to a zone.)

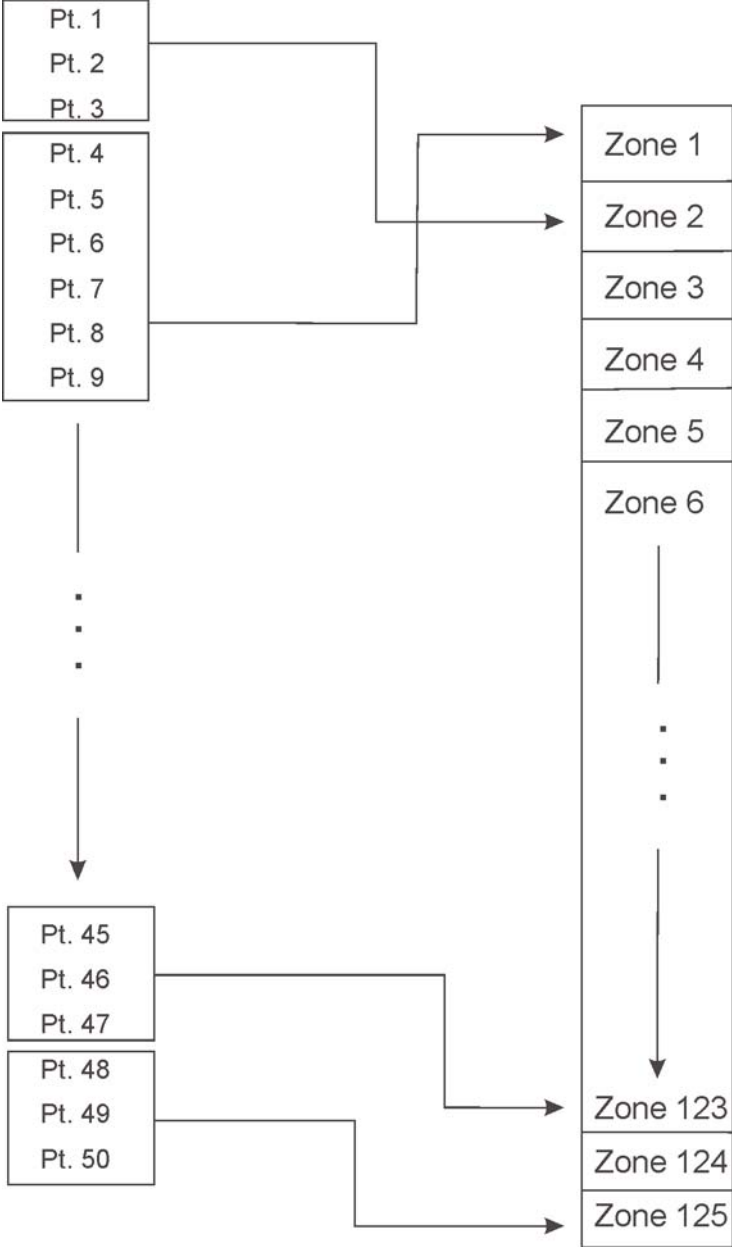

Figure 6-2 Input Point Assignment Example

6.2.2 Output Circuit Mapping

Figure 6-3 is a simple example showing how to assign notification and relay output circuits to groups. For an example of a simple floor above/floor below application, see Figure 6-5.

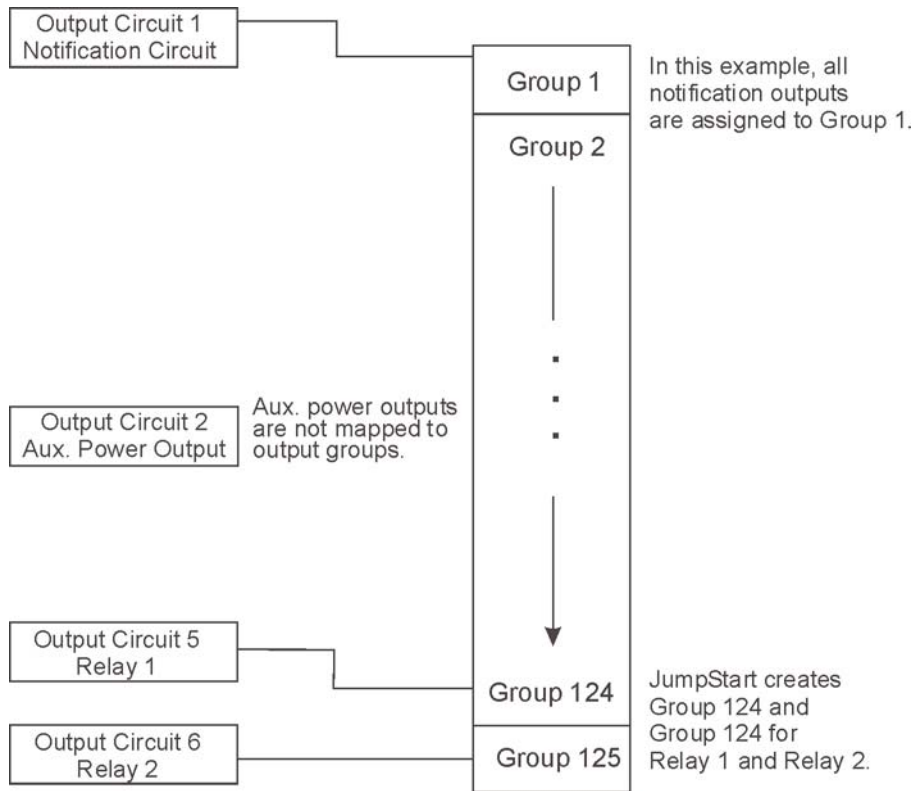

Figure 6-3 Assigning Output Circuits to Groups (Example)

6.2.3 Zone Event Mapping

There are 8 types of events that can occur in zones (see below). For each event type, you can activate up to 8 output groups and patterns. If it is necessary to map to more than 8 output groups, an output group template may be used (see Section 7.3.5 for information on output group templates). Event types are:

- ï Manual Pull Alarm
- ï Water Flow Alarm
- ï Detector Alarm (heat or smoke detectors)
- ï Aux 1 and Aux 2 Alarm (user-specified alarm types)
- ï Pre-alarm
- ï Supervisory
- ï Trouble

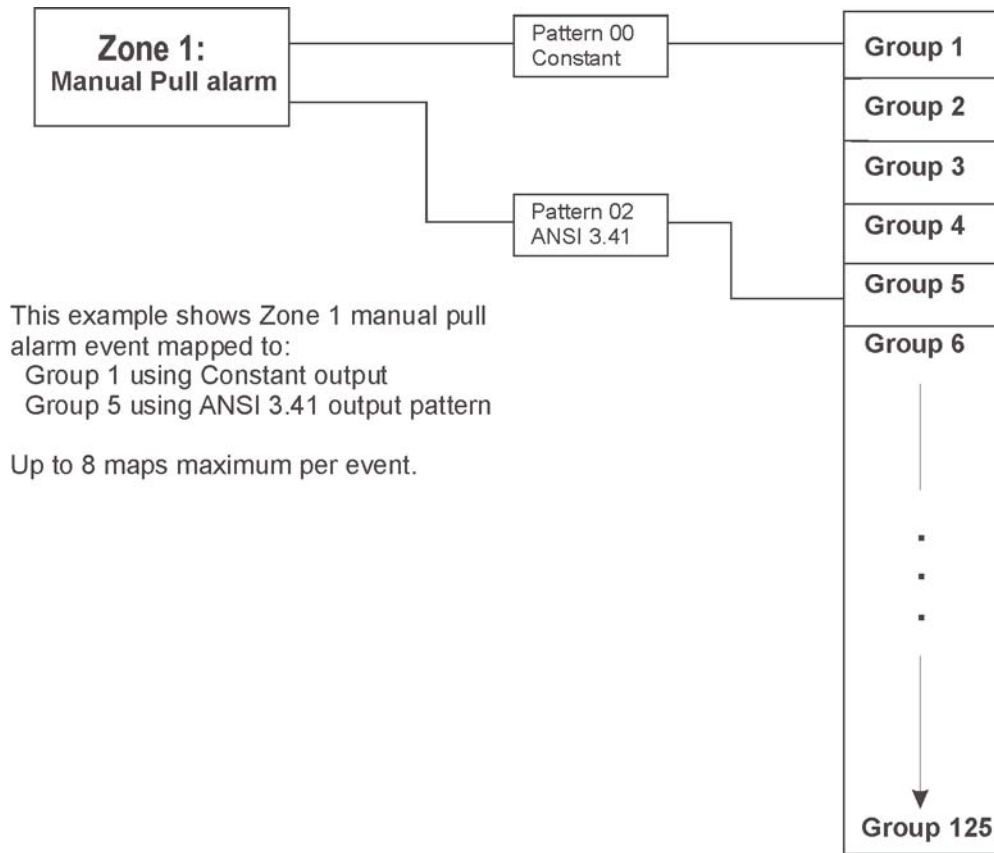

Figure 6-4 Example of Zone Events Mapped to Output Groups and Patterns

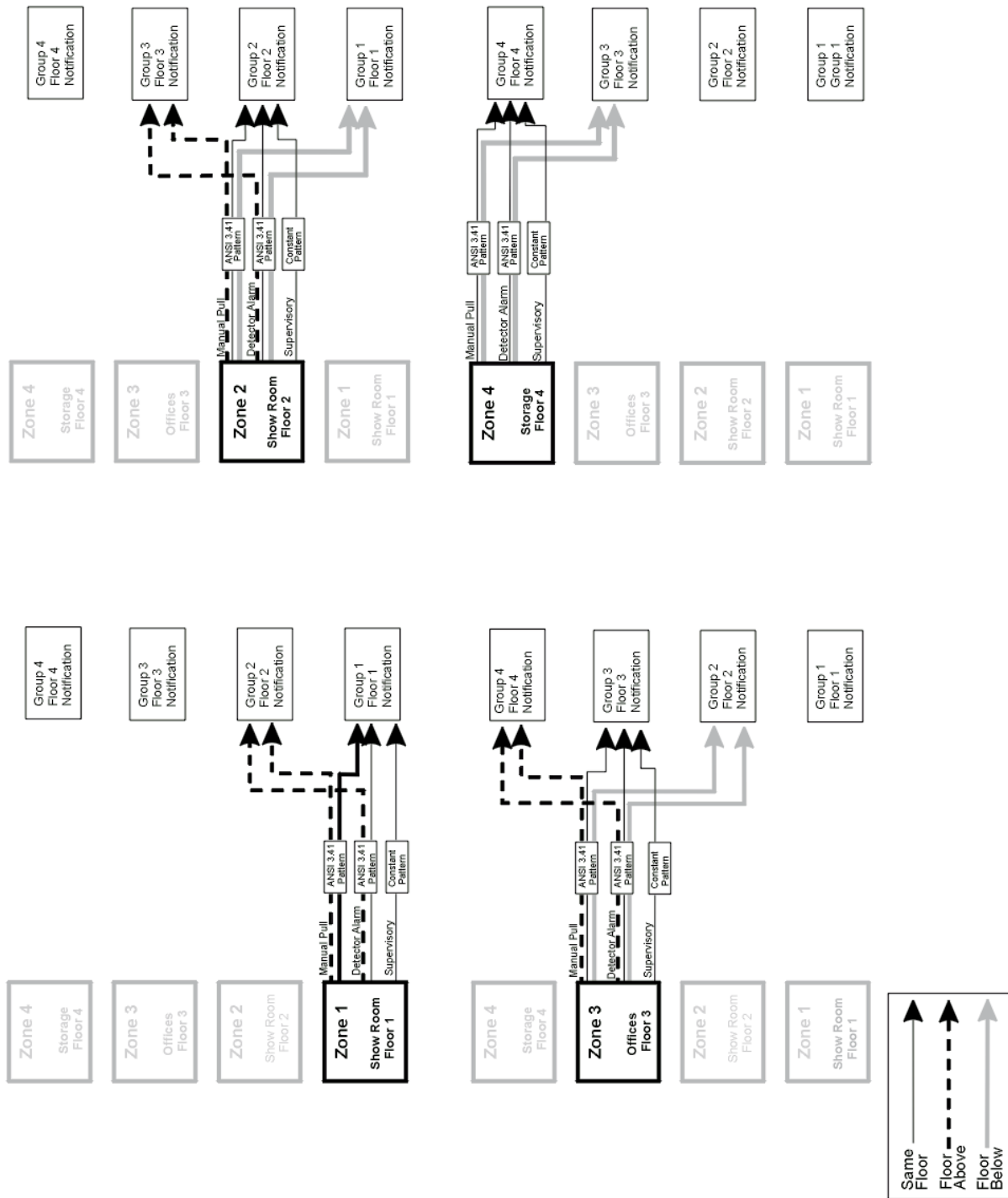

Figure 6-5 Example of Zone Events Mapped to Output Groups and Patterns

6.2.4 Mapping LED Points

Figure 6-6 is a simple example showing how LED points are mapped to zones and output groups. Typically you would create two output groups for each zone, one for alarms and one for troubles. (LED points are available when Models 5865-3/4 and/or 5880 are used with the system.)

Mapping LEDs to Zones and Output Groups

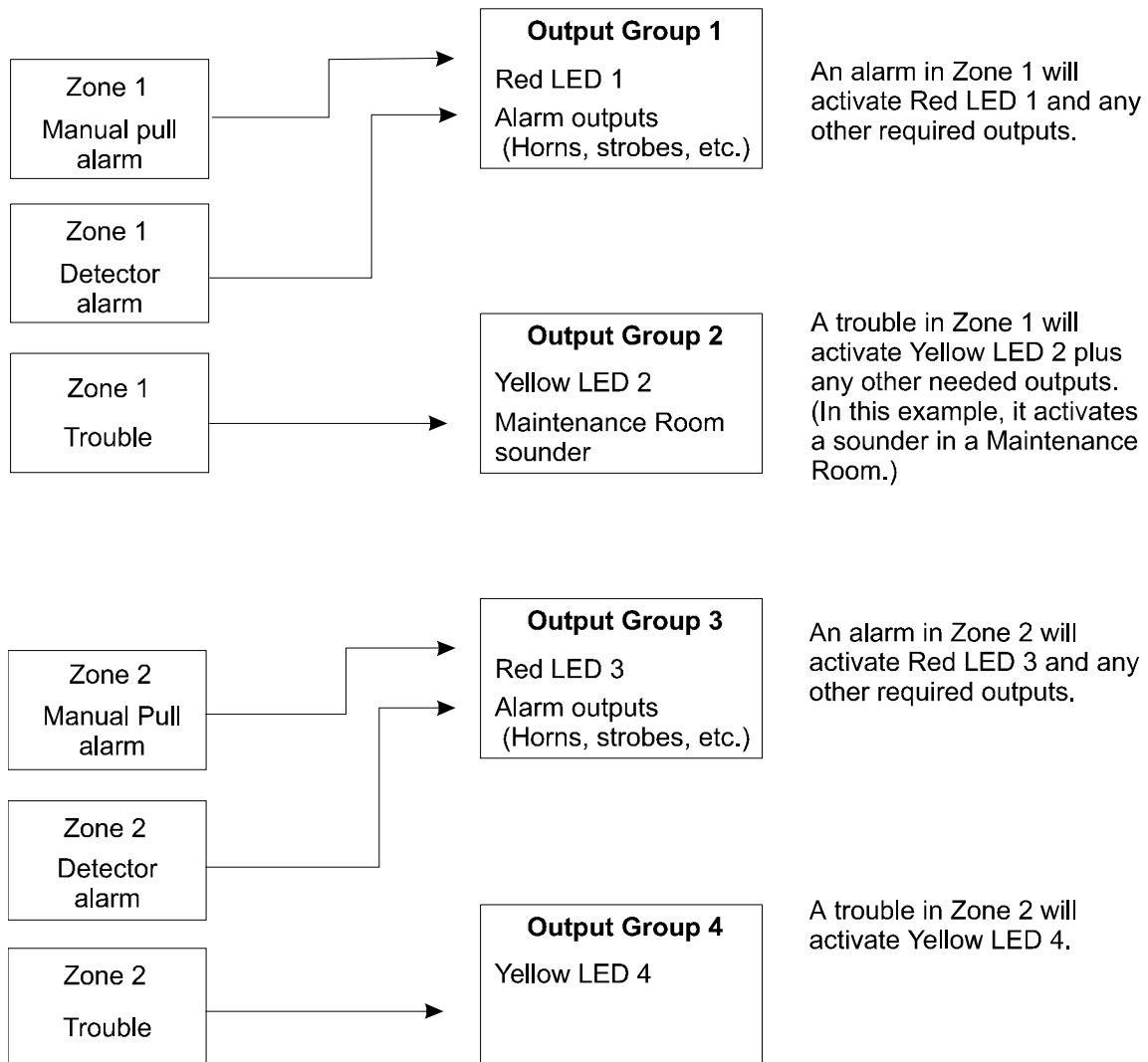

Figure 6-6 Example of LED Points Mapped to Output Groups (applies to Models 5865-3/4 and 5880)

6.3 Silent Knight Software Suite (SKSS)

There are two ways to program the control panel. One way is to program directly from an annunciator, either the on-board annunciator or a Model 5860 Remote Annunciator. Annunciator programming is explained in Section 6.4.

The other method for programming is through the SKSS. The downloading software is an optional software package that allows you to easily program the control panel using a Windows-based computer and a *modem (not sold by Silent Knight). The software works in the following way. First you use the software to program options for the panel, saving the options in a file. You can then download the file to the panel. The software includes an on-line help system and a manual.

* See Section 1.3 for a list of modems that have been tested by Silent Knight for compatibility with the control panel and the Silent Knight Software Suite.

6.4 Annunciator Programming





There are two ways to program a control panel. One way is through the SKSS (see Section 6.3).

The other method is to program directly from an annunciator, using either the on-board annunciator or a 5860 remote annunciator.

The following subsections describe programming basics, including a description of editing keys available for programming and how to move through programming menus. Section 7 contain specific information about individual programming options.

6.4.3 Selecting Options and Entering Data

There are several ways to make programming selections using the control panel depending on which screen you are currently using. The chart below is a generic explanation.

To	Press
Select from a menu.	Enter the number of the option.
Enter numeric data.	Press the appropriate number on the annunciator.
Enter text (alphanumeric data).	Enter each letter individually by pressing and holding any numeric key until the one you wish to select displays. Then press  (right arrow) to select the letter. See Section 6.4 for complete information.
Select from a scrolling list.	Use  (up arrow) and  (down arrow) to move through a list of available options. When the option you want to select is displayed, press  .

6.4.4 Editing Keys

The keys shown in Figure 6-8 are available for use when you are in the Program Menu.

Editing Keys



Use to scroll through the available options within a field.



Use to scroll through the fields on the screen.  (left arrow) backs out of a screen and returns you to a previous menu.



Accepts any changes (moves you to the next field).



Enter numeric and textual data. To enter text, hold down the key until the letters begin displaying. Press  (right arrow) to select when the letter you want is displayed.

Figure 6-8 Editing Keys Available from Program Menu

6.5 Programming Menu Quick Reference

This section of the manual lists all Program Menu options in the order they appear on the sub-menu. Default settings are indicated in text or marked with an asterisk. The comments column provide quick information and a reference to a section (if applicable) which has more detailed information.

Menu	Options/Defaults				Comments	
Module	Edit Module	Select Module	Enter Module Name	Select Class	See Section 4.9	
	Add Module	5860-Keystation			See Section 7.1.2	
		5824-Ser/Par/IO				
		5496-IO/Pwr Sup				
		5880-LED/IO Dev				
		5865-LED Annunc				
Delete Module	List of Modules			See Section 7.1.3		
View Module List	List of Modules					
Zone	Edit Zone	Select Zone to Edit	Edit Zone Name	Enter Name1		
				Enter Number1		
				Enter Name2		
				Enter Number2		
			Zone Properties	Verification Type	*1 Count	
					2 Count	
					Alarm Ver.	
					PAS	
					SNGL ILOCK	
					DBL ILOCK	
					Heat Temp Set	135°F to 150°F
			Zone Outputs		Manual Pull (MP)	(Groups 01 & 250, Pattern 00)
					Water Flow (WF)	
					Detector Alarm (DE)	
					Aux 1 (A1)	no group
					Aux 2 (A2)	
					Pre-alarm (PR)	
					Supervisory (SU)	(Group 249, Pattern 00)
					Trouble (TR)	no group
			Zone Accessry Opt		Cadence	00-20
Local Zone	Yes or No					
Add Zone	Adds next available zone number.			Sec. 7.2.2		
Delete Zone	Select Zone to be Deleted			Sec. 7.2.3		
View Zone Points	List of all points in selected zone.			Sec. 7.2.4		

Menu	Options/Defaults				Comments	
Group	Edit Group	Select Group	Group Name	Enter Name1	See Section 7.3.1.1.	Sec. 7.3.1.1
				Enter Number1		
				Enter Name2		
				Enter Number2		
			Group Properties	Silencing Options	*SILENCE	Silenceable
					NON-SIL	Non-Silenceable Sec. 7.3.1
					Auto Unsilence	Auto Un-silenced Sec. 7.3.1
					SIL-INHIB	Silence after inhib delay. Sec. 7.3.1
					SHUT-DOWN	Automatic Shutdown Sec. 7.3.1
			Group Active With:		Group Activates for all Man. Pull	*No
					Group Activates for Fire Drill	*Yes
					Group Activates for Aux 1	*No
					Group Activates for Aux 2	*No
					Ignore Global Cadence	*No
			Add Group			
Delete Group	Select Group to Delete				Sec. 7.3.3	
View Group Points	Select Group					
Edit OPG Template	Select Template Number	Select Group				
		Include in template	Yes			
			No			
Select Pattern	0-20	0 = Constant. Refer to Figure 7-5				

Menu	Options/Defaults				Comments	
Point	SLC Loop	Enter Pt	UNUSED			
			DETECTOR	PHOTO	Select zone	See Section 7.4.
				HEAT		
				PHOT DUCT		
			SWITCH	MAN_PULL		
				WATERFLOW	LATCH	See Section 7.4.
					NLATCH	
				SUPERVSY	LATCH	
					NLATCH	
				FIREDRILL		
				SILENCE		
				RESET		
				PAS_ACK		
				ZN_AUX1	LATCH	
					NLATCH	
				ZN_AUX2	LATCH	
			NLATCH			
			SYS_AUX1	LATCH		
	NLATCH					
	SYS_AUX2	LATCH				
		NLATCH				
	DETECT SW					
	TAMPER					
	RELAY	OUTPUT PT	Select Group	See Section 7.4.		
		AUX CONST				
		AUX RESET				
		AUX DOOR				
	Internal Pwr and External Power	Select Type	UNUSED			
			B NOTIF	Select Group		
			A NOTIF			
AUX PWR			CONSTANT			
		RESETABLE				
		DOOR				
Select Group or Zone Number		Group or Zone selection will appear depending on the type is selected				
Edit Name		Enter Name		See Section 7.4		
5880		Enter Point #	NOTIF			
			UNUSED			
	Select Group #					
	Edit Name	Enter Name				
5865	Enter Point #	NOTIF				
		UNUSED				
	Select Group #					
	Edit Name	Enter Name		See 7.4		

Menu	Options/Defaults			Comments			
System Options	Reporting Accounts	Edit Acct.	For each account (1-4), select:				
			Edit Account #			*123456	Account # (6-digit number, identifies account to central station) Sec. 7.5.1
			Edit Format			*Contact ID	Reporting Format (SIA, S20, Contact ID) Sec. 7.5.1
			Report Alarms	Y (Yes)		*Yes	Sec. 7.5.1
				N (No)			
				M (Must)			
			Rep. Alarm Restore	Y (Yes)		*No	
				N (No)			
				M (Must)			
			Report Troubles, Supervisories, Enable/Disable	Y (Yes)			
				N (No)			
				M (Must)			
		Report Test	Y (Yes)				
			N (No)				
			M (Must)				
Report Resets	Y (Yes)						
	N (No)						
	M (Must)						
Switch attempts	3 - 5	*5	Sec. 7.5.2				
Edit Phone #1	up to 24 digits	blank	Sec. 7.5.2				
Auto Test Time	Set the Hour	*02:00 AM	Sec. 7.5.1.2				
	Set the Minutes						
	Select AM/PM						

Menu	Options/Defaults			Comments			
System Option (cont.)	Phone Lines	Select Phone Line	For each phone line (1 & 2), select:				
			Dialing Prefix	Up to 8 digits	none	Sec. 7.5.2.1	
			# of Answer Rings	Range: 00-15	06	Number of rings before panel answers a call from a computer Sec. 7.5.2.2	
			Select Dialing Option	TT	TouchTone	Touch Tone	
				TT/PL		TouchTone alternating with pulse see Section 7.5.2.3	
				PULSE		Pulse dialing	
			Rotary Pulse Format	U = 60/40	*U	Sec. 7.5.2.4	
				E = 66/34			
			Line Monitor	Yes	*Yes	Sec. 7.5.2.5	
				No			
			Not Used	Yes = enabled	*N = Disabled		
	No = disabled						
	Answering Machine Bypass	Yes = enabled	*Y = Enabled	Sec. 7.5.2.6			
		No = disabled					
	System Event Outputs	Trouble Events	System Trouble	Select Group	None selected	Sec. 7.5.3.1	
				Select Cadence		Sec. 7.5.3.1	
			Alarm Silence	Select Group	None selected		
				Select Cadence			
			Trbl Silence	Select Group	None selected		
				Select Cadence			
			User Selected	Group Tr	Select Group		
				SBUS Com			
				SBUS Pwr			
				SLC Loop			
				AC Loss			
				Battery			
				Fire Drill		Constant	
				System Aux1	Select Cadence		Sec.7.5.3.2
System Aux2							

Menu	Options/Defaults				Comments
System Option (cont.)	Misc. Options	Water Flow Delay	0 - 90 Seconds	*30 sec	Water Flow delay is the number of sec. before water flow alarm is generated. Sec. 7.5.6.1
		Low AC Delay	6 - 30 hours	*6 hrs	Low AC Report Delay. Sec. 7.5.6.2
		DST	Y (Enabled)	*Enabled	Automatic daylight Savings enable or disable. Sec. 7.5.6.3
			N (Disabled)		
		CLK	AM/PM	*AM/PM	System Clock Format (AM/PM or military). Sec. 7.5.6.4
	MIL				
	AC Freq:	NA		See Section 7.5.6.5	
		60 Hz			
		Neither			
	Misc. Options 2	SYNC Strbs w/ Sil	Y (Enabled)	*Enabled	See Section 7.5.7.1
			N (Disabled)		
		Auto Display Oldest	Y (Enabled)	*Disabled	See Section 7.5.7.2
	N (Disabled)				
	Report By	Zone	*Zone	See Section 7.5.7.3	
		Point			
Misc. Options 3	Alarm Verification time	Enter time from 1 to 250 seconds	*60 Seconds	See Section 7.5.8 Note: For UL installations no less than 60 seconds.	
Edit Banner	Internal Message			See Section 7.5.9	
		Custom Message			Edit Line 1
					Edit Line 2
JumpStart AutoPrg	No		See Section 7.6		
	Yes				
Computer Account	Computer Account #	*123456			See also Section 7.7
	Computer Access Code	*0			
	Computer Phone #	Up to 24 digits			See Section 7.7 for programming phone number.

Menu	Options/Defaults			Comments	
Access Codes	Select Profile (01 - 20)	Edit Name		<p>Profile 1 is the profile that dictates what functions the Fire Fighter Key has access to. Because this is the profile for a key the user name and the access code can not be edited for this profile.</p> <p>Profile 2 is the profile for the installer and is referred to as the "Installer Code". This profiles user name and panel functions can not be edited.</p> <p>See Section 7.8.</p>	
		Edit Access Code			
		Edit Panel Functions	System Reset		
			System Silence		
			System Event Ack.		
			Fire Drill Key		
			System Tests		
			Fire Drill Menu		
			Indicator Test		
			Walk Test no-Report		
			Walk Test w/Report		
			Dialer Test		
			Clear History Buffer		
			Point Functions		
			Disable/Enable Point		
			Point Status		
			Set SLC Device Address		
			SLC Device Locator		
			SLC Multi-Device Locator		
			I/O Point Contol		
			Event History		
			Set Time & Date		
			Printer Options		
			Event Logging		
			Print Event History		
			Print Detector Status		
		Print System Config			
Reset Dialer					
Program Menu					
System Information					
Upload/Download					

- From the next screen, select the number that corresponds to the type of module you are adding from the <New Module Type> screen.

The screen will display `Adding module [#]...` for a few moments. You will be returned to the <New Module Type> screen where you can select another module if desired.



You must save changes when you exit the Program Menu or the new module will not be added.

Note: If you Add a Module that has not been physically connected, the panel will go into trouble after it reinitializes (when you exit the Program Menu). When the new module is attached, the trouble will correct itself automatically the next time you power up the system.



7.1.3 Deleting a Module

If you ever need to delete a module, follow these steps.

You must be in the Main Menu to perform this task. If necessary, enter the Installer Code.

- Press  or  to display the main menu.
- Enter the installer code if requested.
- Select  for Program Menu.

```
Display reads:      Initializing
                   Please wait . . .
```

- Press  to enter module menu.
- Press  to delete a module.
- A warning screen will display. If you want to proceed with deleting the module, select Yes. To cancel, select No.

8. Select the characters for the zone name by pressing the ▲ or ▼ arrow until the desired character is shown then press ▶.

OR

Enter the Numerical Designator for the character you want, then press ▶. See Appendix B Table B-1 of this manual for a list of available characters and their numeric designators.

9. Repeat step 8 until the name is complete.

10. Press  when the name is complete.

7.2.1.2 Edit Zone Properties

Zone properties consist of, alarm delay characteristics, and heat detector sensitivity.

1. Do steps 1 through 6 of Section 7.2.1.
2. Press  to edit the properties of the selected zone.

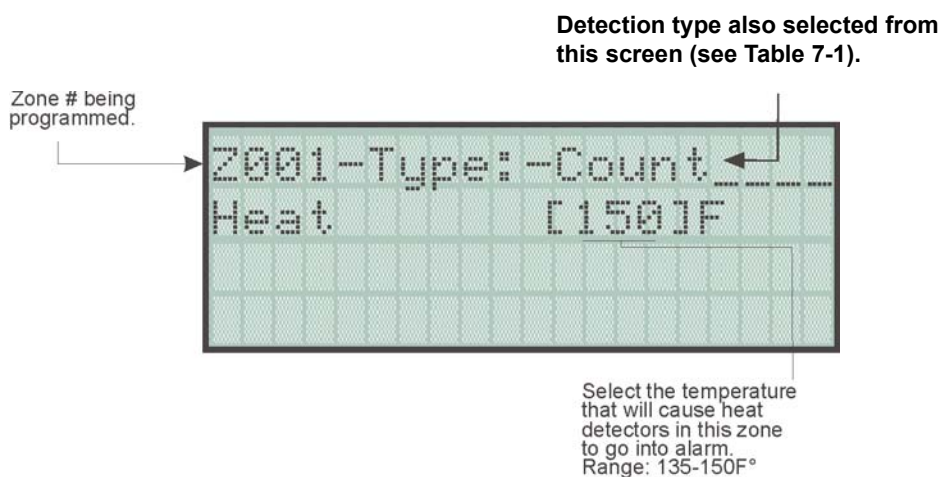

Alarm Delay Characteristics



3. Select the alarm delay characteristics by pressing the  or  arrow.

Table 7-1 list the delay choices and a description of each.

Table 7-1: Alarm Delay Types

Type of Delay	Description
1-Count	One Count (No Delay). When this option is enabled, an alarm occurs immediately when a single device of any of the following types goes into alarm: detector, manual pull, water flow, Aux1 or Aux2. This is considered the most typical operation and is the default for all zones.
2-Count	When this type of alarm delay is used, two or more detectors within the zone must go into alarm in order for the zone to report an alarm. Switches of type manual pull, water flow, Aux1 and Aux2 are an exception; they will cause an alarm when only one switch is in alarm. When a single detector is in alarm in a 2-Count zone, the system enters a prealarm condition. In a prealarm condition, the touchpad PZT beeps and the annunciator display indicates that a prealarm has occurred. If the zone has been mapped to an output group for the prealarm event, the output group will activate. The prealarm will not be reported to the central station.
Alarm Ver.	Alarm verification is an optional false alarm prevention feature that verifies an alarm condition by resetting the smoke detector. If the alarm condition still exists by the time the reset cycle has completed, the detector will go into alarm. If the detector is no longer in alarm, no report will go to the central station. The alarm verification sequence is ignored if the zone is already in alarm.
PAS	This option is intended to be used with an acknowledge switch. An alarm is delayed for 15 seconds, giving on-site personnel a chance to investigate the alarm. If the acknowledge switch is not activated within 15 seconds, an alarm occurs automatically. If this option is enabled for a zone, the zone will respond to an alarm condition as follows: <ul style="list-style-type: none"> i The zone will not go into alarm for 15 seconds to allow an on-site operator to activate the acknowledge switch. i If the operator does not press the acknowledge switch within 15 seconds, the zone will go into alarm. i If the operator presses the acknowledge switch within 15 seconds, a 180-second time-frame will begin counting down. This time-frame allows the operator to investigate the cause of the alarm. <p>If the operator performs a reset within 180 seconds, the alarm will not occur.</p> <p>If the operator does not perform a reset within 180 seconds, an alarm will occur automatically.</p>
SNGL ILOCK	See Section 8.5.1 for single interlock releasing operation.
DBL ILOCK	See Section 8.5.2 for double interlock releasing operation.

4. Press .



Heat Temperature Setting

Use this feature to set the temperature that heat detectors will respond. The range is 135°F to 150°F. All detectors in the zone will respond in the same way.

The Model SD505-AHS Heat Detector is an absolute temperature device. This means that it responds to an alarm immediately if the temperature in the zone goes above the programmed temperature.

5. Enter the temperature that the heat detector will respond.

Or

Use the  or  keys to scroll through the range or enter directly from the number keys on the annunciator.

Then press .

7.2.1.3 Zone Outputs

Output groups and cadence patterns are mapped to events. They can be programmed to output when an event occurs in a zone. Some system trouble events can be mapped for the entire system. Section 6.2 of this manual contains a general explanation of mapping. The following sections explain how to select mapping options.





Mapping to Zone Events

Eight types of events can occur in zones. For each event type, you can activate up to 8 output groups or output group template, specifying a pattern for each.

Event types are:

- i Manual Pull Alarm
- i Water Flow Alarm
- i Detector Alarm (heat or smoke detectors)
- i Aux 1 and Aux 2 Alarm (user-specified alarm types)
- i Pre-alarm
- i Supervisory
- i Trouble

To map zone events to outputs, follow these steps:

1. From the Main Menu, select  for Program Menu.
2. From the Program Menu, select  for Zone.
3. From the next menu, select  for Edit Zone.
4. Enter the zone number you wish to edit.
5. From the next menu, select  for Zone Outputs.
6. From the next screen, a list of 8 event types will display. Select the event type you want to program. A screen similar to the one shown in Figure 7-3 will display. Press .

7.2.1.4 Cadence Patterns

The cadence patterns shown in Figure 7-5 are available for use with the control panel.

Cadence patterns can be selected by event type for each zone or for the entire system. Special cadence patterns can be selected for fire drills and any auxiliary system switches used with the system..







#	Name	Pattern Description																										
00	Constant	Continuous sound <small>Patterns repeat until condition is cleared.</small> Note: This is the only pattern that can be used for relay circuits. The system will override any other choice.																										
01	March Code																											
02	ANSI 3.41																											
03	Single Stroke																											
04	California																											
05 ⋮ 16	Zone Coded	<table border="1" data-bbox="300 1155 560 1522"> <thead> <tr> <th>Pattern#</th> <th>Zone</th> </tr> </thead> <tbody> <tr><td>5</td><td>Zone 1</td></tr> <tr><td>6</td><td>Zone 2</td></tr> <tr><td>7</td><td>Zone 3</td></tr> <tr><td>8</td><td>Zone 4</td></tr> <tr><td>9</td><td>Zone 5</td></tr> <tr><td>10</td><td>Zone 6</td></tr> <tr><td>11</td><td>Zone 7</td></tr> <tr><td>12</td><td>Zone 8</td></tr> <tr><td>13</td><td>Custom 1</td></tr> <tr><td>14</td><td>Custom 2</td></tr> <tr><td>15</td><td>Custom 3</td></tr> <tr><td>16</td><td>Custom 4</td></tr> </tbody> </table>  <p>EXAMPLE: Pattern 06, Zone 2 coded</p> 	Pattern#	Zone	5	Zone 1	6	Zone 2	7	Zone 3	8	Zone 4	9	Zone 5	10	Zone 6	11	Zone 7	12	Zone 8	13	Custom 1	14	Custom 2	15	Custom 3	16	Custom 4
Pattern#	Zone																											
5	Zone 1																											
6	Zone 2																											
7	Zone 3																											
8	Zone 4																											
9	Zone 5																											
10	Zone 6																											
11	Zone 7																											
12	Zone 8																											
13	Custom 1																											
14	Custom 2																											
15	Custom 3																											
16	Custom 4																											
17 ⋮ 21	<table border="1" data-bbox="300 1543 560 1680"> <thead> <tr> <th>Pattern #</th> <th>Sync Type</th> </tr> </thead> <tbody> <tr><td>17</td><td>Faraday</td></tr> <tr><td>18</td><td>Gentex</td></tr> <tr><td>19</td><td>System Sensor</td></tr> <tr><td>20</td><td>Wheelock</td></tr> <tr><td>21</td><td>Not Used</td></tr> </tbody> </table>	Pattern #	Sync Type	17	Faraday	18	Gentex	19	System Sensor	20	Wheelock	21	Not Used	<p>These outputs provide synchronization for Faraday, Gentex, System Sensor or Wheelock synchronized appliances.</p>														
Pattern #	Sync Type																											
17	Faraday																											
18	Gentex																											
19	System Sensor																											
20	Wheelock																											
21	Not Used																											

Figure 7-5 Cadence Patterns Available with the Control Panel

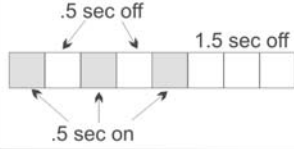
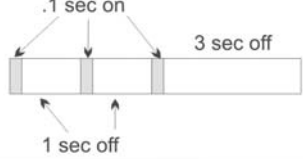
Note: When select cadence paterns for Alarms, Supervisories, or troubles they must be distinctive from each other.

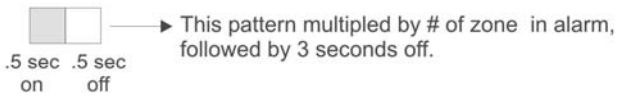
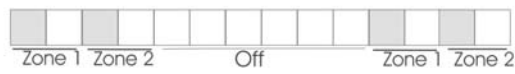
8. Select the characters for the group name by pressing the  or  arrow until the desired character is shown then press .

OR

Enter the Numerical Designator for the character you want, then press . See Appendix B Table B-1 of this manual for a list of available characters and their numeric designators.

9. Repeat step 8 until the name is complete.

10. Press  when the name is complete.

7.3.1.2 Edit Group Properties

The Edit Group Menu allows you to select options for each group for the following items:

- i Latching or non-latching outputs.
- i Silencing operation.
- i Operation with system switches.

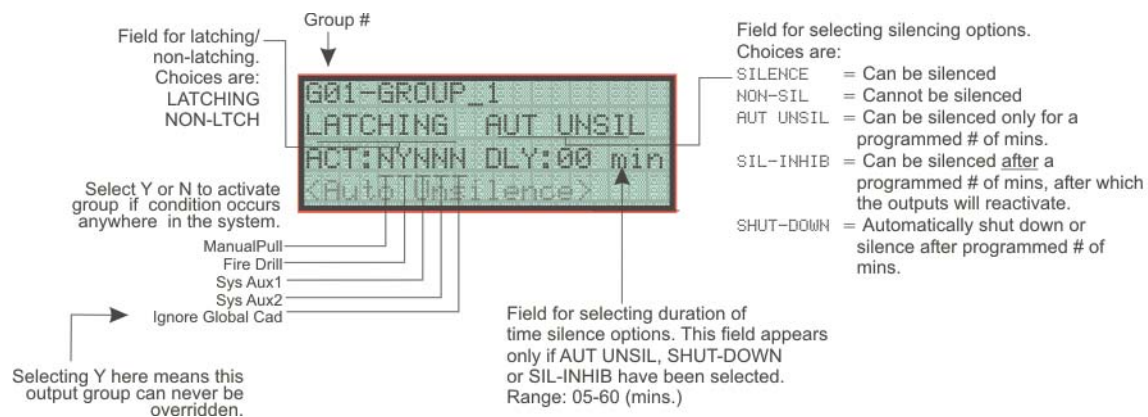

Figure 7-8 Group Properties Screen Programming Options



Latching / Non-latching Outputs

Outputs that are programmed as Latching remain active until the system has been manually reset. Non-latching outputs stop activating automatically when the condition clears.

Silencing Options

The following silencing options are available for each output group.

Table 7-2: Silencing Options

Option	Description
SILENCE	Silenceable. The output group can be silenced through the  key.
NON-SIL	Not silenceable. The output group cannot be silenced. Activation of the  key will be ignored for this output group.
AUT UNSIL	Auto Unsilenced. If this option is selected, the output group can be silenced for a programmed time-frame. If the condition that caused the output to activate has not cleared during the time-frame, the output reactivates. If you select this option, select the time-frame in the DLY: field. Range is 01-60 minutes. (See Figure 7-8 for location of field.)
SIL-INHIB	Timed Silence after Inhibit. If this option is selected, the output group must be audible for a programmed number of minutes before it can be silenced. If the condition that caused the output to activate has not cleared during the time-frame, the output can be silenced. If you select this option, select the timeframe in the DLY: field. Range is 05-60 minutes. (See Figure 7-8 for location of field.)
SHUT-DOWN	If this option is selected, the output group will automatically silence (shut down) after the programmed time period. If you select this option, select the timeframe in the DLY: field. Range is 05-60 minutes. (See Figure 7-8 for location of field.)

Response with System-Wide Conditions









You can select whether an output group will respond to various system-wide occurrences. (See Figure 7-8 for location of this field.)

Table 7-3: Output Group Response Choices

Option	Description
ManPull	Manual Pull Activation. Select Yes if you want this group to activate for all manual pull alarms that occur in the system. Note: Even though manual pull switches are assigned to zones, activation selected here for manual pull will override zone-programmed activation.
Fire Drill	Fire Drill Activation. Select Yes if you want this group to activate for fire drills.
Sys Aux1 and Sys Aux2	Select Yes if you want this output group to activate for system-wide Aux1 and Aux2 alarms. (Aux 1 and Aux 2 alarm types are for auxiliary alarm conditions. For example, you might want to use Aux 1 to provide a unique alarm type and sound for a severe weather condition.)
Ignore Global Cad	Ignore Global Cadence. If you want to create an output group that can never be overridden, you can select Yes for this option. Selecting No means that system-wide events that have been assigned an output pattern could override the pattern for the output group. For example, suppose you had assigned a set of strobes to Output Group 3. You would never want these strobes to output in a pattern under any circumstances. To make sure this happens, select Yes for Ignore Global Cadence for Output Group 3.



11. To get to this menu item repeat steps 1 through 6 of section 7.3.1.

12. To edit group properties, press .



13. Press the  or  arrows to select the desired latching option.
14. Press .
15. Press the  or  arrows to select the desired silencing option. Refer to Table 7-2.
16. Press .
17. Enable group activation for a condition (see Table 7-3) by pressing the  or  arrows to select Y (yes) or N (no).
18. Press .
19. Repeat steps 14 and 15 for all the activation options.

7.3.2 Add Group

To add a group, follow these steps:



1. Press  or  to display the main menu.
2. Enter the installer code if requested.
3. Select  for Program Menu.

```
Display reads:      Initializing
                  Please wait . . .
```

4. Press  to enter group menu.
5. Press  to add a group.

The system will assign the next available group number. Properties for the new group can now be edited if desired (see Section 7.3.1.2). A total of 125 output groups can be defined.

7.3.3 Delete Group

1. Press  or  to display the main menu.
2. Enter the installer code if requested.
3. Select  for Program Menu.

```
Display reads:      Initializing
                  Please wait . . .
```

4. Press  to enter group menu.

5. Press **3** to delete a group.

A warning screen will display. If you want to proceed with deleting the group, select Yes. To cancel, select No.

7.3.4 View Group Points

1. Press **▶** or **ENTER** to display the main menu.
2. Enter the installer code if requested.
3. Select **7** for Program Menu.

Display reads: Initializing
 Please wait . . .

4. Press **3** to enter group menu.
5. Press **4** to view group points.
6. Enter the group number, then press **ENTER**.

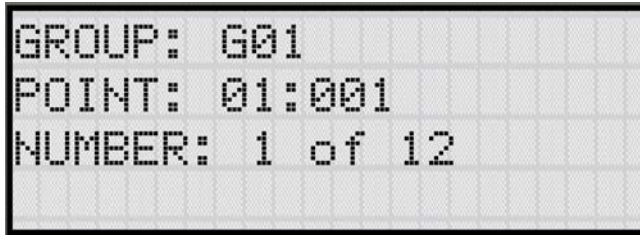

7.3.5 Edit Output Group Templates

Some installations may require that zones be mapped to more than 8 output groups. With output group templates you can combine one or all output groups into one template, which can be used when the same combination of outputs are used for several zones.

For example, lets say an installation has five zones (See table below). The check mark indicates what output groups are mapped to each zone. You will notice that every zone is mapped to outputs 1 and 2. As an alternative you can create a template that combines output group 1 and 2 as one choice.

Zone	Group Number							
	1	2	3	4	5	6	7	8
1st Floor Smoke Detectors	✓	✓			✓			
2nd Floor Smoke Detectors	✓	✓			✓			
3rd Floor smoke Detectors	✓	✓			✓			
Manual Fire Pull Stations	✓	✓					✓	
Water Flow Switches	✓	✓						✓

This can be done by creating a template which includes output groups 1 and 2. Then you can map all the zones to the template you created. This will free up output group assignments that are common to several zones. This is very useful when you need to map zones to more than eight output groups.

To create Output Group Templates:

1. From the Main Menu, select **7** for Program Menu.
2. From the Program Menu, select **3** for Group.
3. At the next screen, select **5** for Edit OPG Template.
4. Select the template number (01 - 08).
5. Select output group number. See Figure 7-9.

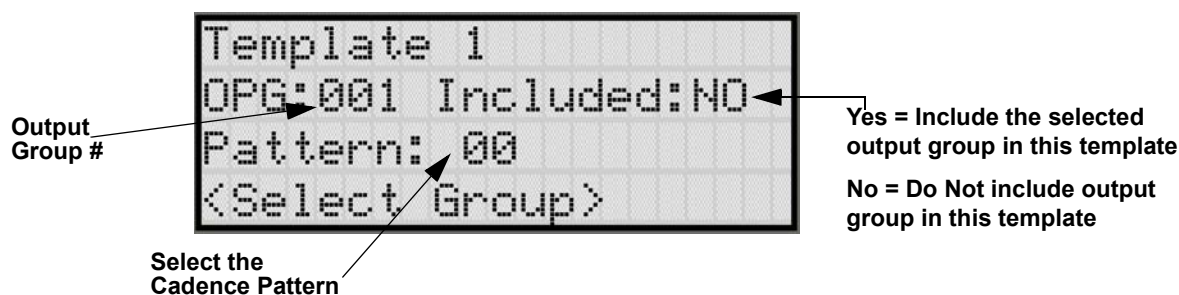

Figure 7-9 Output Group Template Programming Screen



- Select the type of device by pressing the  or  arrows. Refer to Table 7-4 under column heading "Type Selection" for a list of choices.

Table 7-4: Point Programming



Module Type	Type Selection	Function	Latching Option	Comments	
SLC	UNUSED				
	DETECTOR	PHOTO			
		HEAT			
		PHOT DUCT			
	SUP DET	SUP PHOTO			
	SWITCH	MAN_PULL			Use this switch type for manual pull stations. This input is always latched. The switch can clear only when an alarm is reset. This switch type has the highest priority; it overrides any other type of alarm.
		WATERFLOW	Latching		Use this switch type for monitoring water flow in a sprinkler system. Switch closure will cause a sprinkler alarm. Water flow switches can be programmed as latching or non-latching. You can program a delay of up to 90 seconds to be used with a water flow switch. The delay allows for normal, brief changes in sprinkler system water pressure. The water flow alarm will not activate unless the switch is active for the programmed delay time.
			Non Latching		Note: Waterflow delay of the FACP and the water-flow device shall not exceed 90 seconds. If a delay is used, the system begins counting down when the switch closes. If the switch opens (restores) before the timer expires, a water flow alarm is not generated. If the water flow switch remains closed after the timer expires, a water flow alarm will be generated.
		SUPERVISY	Latching		Use this switch type for tamper monitoring of sprinklers and other fire protection devices. If a contact closes, a sprinkler supervisory event will be generated. Supervisory switches can be latching or non-latching.
			Non Latching		
		FIREDRILL			System-level, non latching switch. This switch is an alternative way of causing a fire drill. It has the same operation as the fire drill option available from the annunciator. When the switch is activated, a fire drill begins; when the switch is de-activated, the fire drill ends.
		SILENCE			This system-level switch is an alternative way to silence the system. It has the same effect as pressing the  key.
		RESET			This system-level switch is an alternative way to reset the system. It has the same effect as pressing the  key.

Table 7-4: Point Programming

Module Type	Type Selection	Function	Latching Option	Comments
SLC (Continued)	SWITCH (Continued)	PAS_ACK		Positive acknowledge switch. This switch must be used in zones programmed as Positive Alarm Sequence (see Table 7-1). If an acknowledge switch closes when an alarm or trouble condition is not already in progress, a trouble will occur. You must use a UL listed normally open, momentary switch type. The switch must be rated at 5V, 100 mA (minimum) and be used with an EOL resistor for supervision.
		ZN_AUX1	Latching	Use these switch types if you want to monitor special zone-level conditions.
			Non Latching	
		ZN_AUX2	Latching	
			Non Latching	
		SYS_AUX1	Latching	Use these switch types if you want to monitor special system-wide conditions.
			Non Latching	
		SYS_AUX2	Latching	
			Non Latching	
		DETECT SW		Used to monitor conventional 4-wire detectors, a contact closure will generate a detector alarm event.
	TAMPER	Latching	Performs identically to a supervisory switch, but will be indicated as a tamper switch on the LCD annunciator.	
		Non Latching		
	MAN REL	Latching	Manual release switch, typically a pull station.	
		Non Latching		
	ILOCK	Latching	Interlock release switch input.	
Non Latching				
RELAY	OUTPUT PT	Select Group	Output Point, a general use relay type. Use for applications requiring a relay, such as elevator recall, and so on.	
	AUX RESET	Select Group	Use for auxiliary power, resettable applications. See Section 4.11.2.3 for a description of how this option operates.	
	AUX DOOR	Select Group	Use for auxiliary power, door holder applications. For example, if you were using an auxiliary power supply for door holders, you would use this option. See Section 4.11.2.1 for a description of how this option operates.	

6. Press .

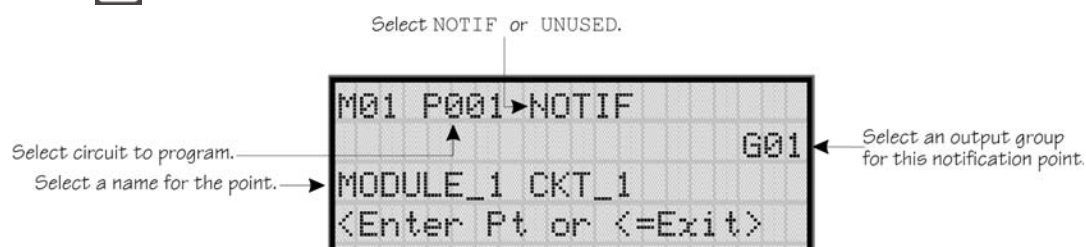









Figure 7-10 Programming Points Screen for 5880 and 5865 Modules

7. Enter the point number.
8. Press .
9. Press the  or  arrows to select the type (Notification or unused).
10. Press .
11. Press the  or  arrows to select the desired Group.
12. Press .
13. Edit module name. See Section 7.4.3.1.

Or





Press  to skip module name edit.

14. Repeat Steps 1 through 13 for all points.

7.4.3.1 Assigning a Name to a Points

You can assign a name to a point to make it easier to recognize on a display.

If you wish to edit the name of a point, follow these instructions:

1. Do steps 1 through 4 of Section 7.4.3.
2. Using the  or  arrow, select the module of the point you want to edit, press .
3. Enter the point number.
4. Press  until the module name is blinking.

5. Press .

A screen similar to the one shown in Figure 7-11 displays.

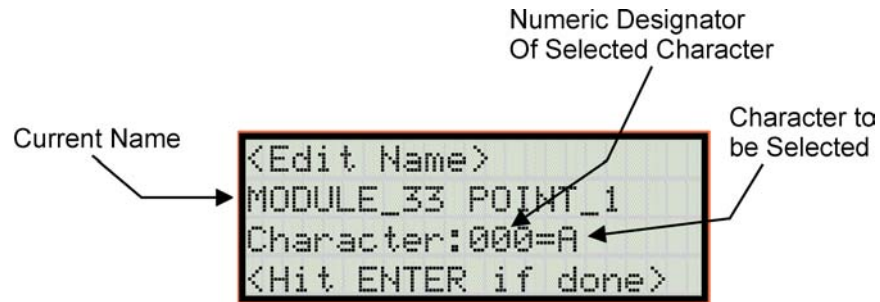







Figure 7-11 Selecting Character for Zone Name

6. Select the characters for the point name by pressing the  or  arrow until the desired character is shown then press .

OR

Enter the Numerical Designator for the character you want, then press . See Appendix B Table B-1 of this manual for a list of available characters and their numeric designators.

7. Repeat step 6 until the name is complete.
8. Press  when the name is complete.

7.5 System Options

This section of the manual explains how to customize software options that affect general operation of the system. This includes such items as: AC loss hours, system clock options, holidays schedule, telephone and reporting account options. Refer to each individual subsection for complete instructions.

7.5.1 Reporting Account



Up to four reporting accounts can be used with the control panel. Events in accounts are reported by zone.

Each account is assigned an up-to-6-digit account number. Each account is also assigned a unique ID (1-4) which determines the priority for reporting ("1" has the highest priority; "4" has the lowest).



Disable any unused accounts by selecting "N" for all events (see Figure 7-12, next page). If the system is local only (does not connect to a central station), disable all events for all four reporting accounts.

Options for each account can be customized. These options appear on the Reporting Accounts screen. Some related options appear on the Phone Lines screen (see Section 7.5.2).

To access the Reporting Accounts screen:

1. Press  or  to display the main menu.
2. Enter the installer code if requested.
3. Select  for Program Menu.

```
Display reads:      Initializing
                   Please wait . . .
```

4. From the Program Menu, select  for System Options.
5. From the next menu, select  for Reporting Accounts.

7.5.1.1 Edit Accounts

- From the next menu, select **1** for Edit Account.

A screen similar to one shown in Figure 7-12 will display. The following subsections describe the options on each field.

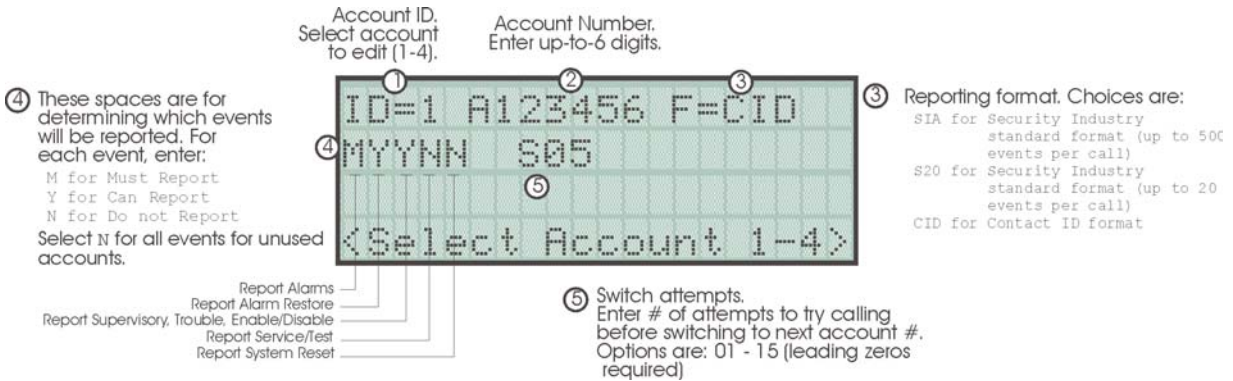

Figure 7-12 Reporting Account Editing Screen

Select Account (ID)

The control panel provides up to 4 reporting accounts. The priority of an account is based on its account ID. Account 1 is highest priority; Account 4 is lowest. Use Account 1 to report the highest priority events.

- Press the **▲** or **▼** arrow to select account ID number, then press **ENTER**.

Edit Account Number



Enter an up-to-6-digit number for each account to identify the account to the central station. See Figure 7-12 for location of this option on the screen. The account number should be compatible with the reporting format used. For example, the Contact ID format transmits up to four digits only.

- Enter the desired account number (up to 6-digits), then press **ENTER**.

Select Reporting Format

Select a reporting format for each account. Options are:



SIA	SIA format. 500 events per call.
CID	Ademcois Contact ID format
S20	Same as SIA but limits events reported to 20 events per phone call.

9. Press the  or  arrow to select the reporting format, then press .

Events to Report

The next six options select which types of events (or event families) will be reported to this account. (See Figure 7-12 for location of these options on the screen.) Events are reported by zone.

Event Family	Events Included in this Family
Alarms	All alarms (Water Flow, Manual Pull, Detectors, Auxiliary Switches)
Alarm Restore	All alarm restores.
Supervisory, Trouble, Enable/ Disable Point	All trouble and supervisory conditions and trouble and supervisory restores. Enabling and disabling of input and output points.
Service/Test	Fire drill, walk test, dialer test, automatic test, all programming sessions.
System Reset	All system resets.

10. Press the  or  arrow to select Must, Yes, or No (see Table below), then press .



11. Repeat step 10 for all five event report options.

For each event family, select M, Y, or N.

M(ust)	Must Report. Selecting "M" makes this a primary reporting account for this family of events. The dialer MUST report events in this family to this account. Selecting Must makes an account a primary reporting account. The dialer will try to report the event to the primary account until it exceeds the "Switch Attempts" value. When the dialer has exceeded the Switch Attempt retry limit, it will switch to a backup account (a "Can Report" or "Yes" account, see below). If the dialer cannot report the event to any of the backup accounts, it will return to the primary account and repeat the process until it exceeds the "Fail Attempts" value. If the Fail Attempts limit is exceeded, an Account Trouble condition is generated and a local trouble will sound.
Y(es)	Can Report. Selecting Y makes this a backup account for this event family. The dialer will report to this account only if it was previously unable to report the event to a Must account.
N(o)	No events in this family will ever be reported to this account.

Switch Attempts

Specify the number of times the dialer should attempt to report to this account before switching to the next account. Range is 01-15.

12. Enter the number of switch attempts (or press the  or  arrow), then press .

7.5.2.2 Number of Answer Rings

This option is used in conjunction with the Silent Knight Software Suite 5660. Use the option to determine the number of rings before the panel answers a call from the computer. Range is 00-15 rings. This option is factory-programmed as 06 rings, which should be compatible for most installations where the answering machine bypass feature is used. You may need to adjust it depending on the installation's telephone system.

The selection made here must match the programming for this option in the Communication Configuration dialog box of the 5660 software. See the manual for the software (p/n 151240) if you need more information.



8. Enter the desired number of answer rings, then press .

7.5.2.3 Dial Option (TouchTone or Pulse)

9. Press the  or  arrow to select the dial option, then press .

Dial Option	Description
PULSE	If this option is selected, only pulse dialing will be used for this phone line.
TT	TouchTone dialing. If this option is selected, only TouchTone dialing will be used for this phone line.
TT/PL	TouchTone alternating with pulse. If this option is selected, the dialer will first attempt to use TouchTone. It will switch to pulse if TouchTone is not successful on the first attempt. It will continue to alternate between TT and pulse for additional attempts.

7.5.2.4 Rotary Format

10. Press the  or  arrow to select the pulse ratio for rotary dialing option, then press .

Options are:

Table 7-7: Pulse dialing Ration Selections

U	U.S. standard format. Uses the 60 msec / 40 msec make/break ratio.
E	European format. Uses the 66 msec / 34 msec make/break ratio.

7.5.2.5 Line Monitor

Enable the line monitor for each phone line that will be used. See Figure 7-13 for location of this field on the phone lines screen. When the phone line monitor has been enabled for a phone line, a trouble condition will occur if the line is not connected. If a phone line will not be used, it must be disabled.

11. Select Y (monitor line) or N (don't monitor line) by pressing the  or  arrow, then press .

7.5.2.6 Answering Machine Bypass



This option is used in conjunction with the Silent Knight Software Suite 5660. This feature ensures that an answering machine will not interfere with communication between the panel and the computer. If an answering machine is used at the panel site, enable this feature; if an answering machine is not used, disable the feature.



This option is factory-programmed as Yes (enabled).

The selection made here must match the programming for this option in the Communication Configuration dialog box of the 5660 software. See the manual for the software (p/n 151240) if you need more information.

12. Select Y (answering machine bypass enabled) or N (answering machine bypass disabled) by pressing the  or  arrow, then press .

7.5.3 Sys. Event Outputs

1. Enter the installer code.
 1. Press  or  to display the main menu.
 2. Enter the installer code if requested.
 3. Select  for Program Menu.

Display reads: Initializing
 Please wait . . .
 4. From the Program Menu, select  for System Options.
 5. From the System Options Menu, select  for Sys. Event Outputs.

7.5.3.1 Trouble Events

You can map certain system trouble events to an output group. To access the screen for selecting output groups and cadence patterns for system trouble events.

- Press **1** for Trouble Events. A screen similar to the one in Figure 7-14 will display. Select a group and a cadence pattern for each event as needed for your application. The U: field is for a user-specified trouble condition. You can program an output group and cadence pattern for any of the following events:

Battery	Low battery condition.
Gnd Flt	Ground fault.
Phone Ln	Phone Line 1 or 2 trouble.
Account	Account trouble; cannot report to account.
Printer	Printer trouble. (Currently not supported; do not select.)
Aux Pwr	Auxiliary power trouble.
Sys Sw	Trouble with a system switch.
Group Tr	Trouble with an output group.
SBUS Com	SBUS communication trouble.
SBUS Pwr	SBUS power trouble.
SLC Loop	Trouble on the SLC loop.
AC Loss	AC power lost.

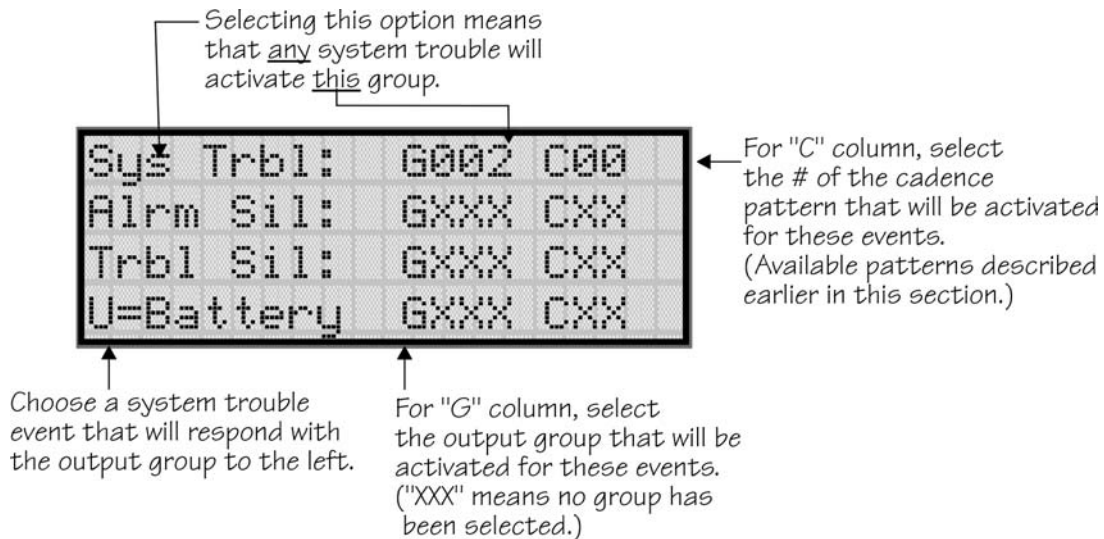







Figure 7-14 System Trouble Event Mapping Example

7.5.3.2 System Alarm Cadence

Fire drill and system auxiliary alarm events can have special cadence patterns to distinguish them from other types of alarms. See Section 7.2.1.4 for available cadence patterns.

A typical use of the System Aux1 and Aux2 patterns is to distinguish fire emergencies from other types of emergencies (such as a tornado or other weather condition). For example, you could use one pattern for fire drills and a different pattern for severe weather conditions. The System Aux1 and Aux2 alarms would be triggered by a system-wide switch.

To access the screen for selecting output groups and cadence patterns for system trouble events:

1. Press  or  to display the main menu.
2. Enter the installer code if requested.
3. Select  for Program Menu.
 Display reads: Initializing
 Please wait . . .
4. From the Program Menu, select  for System Options.
5. From the System Options Menu, select  for Sys. Event Outputs.
6. Press  for System Alarm Cadence.

A screen similar to the one in Figure 7-15 will display. Select a cadence pattern for these special events if required for your application.

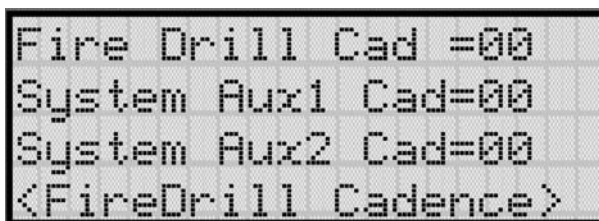

```

Fire Drill Cad =00
System Aux1 Cad=00
System Aux2 Cad=00
<FireDrill Cadence>
  
```

Figure 7-15 Special Cadence Patterns for Fire Drill and Auxiliary Alarm Events

7.5.4.2 Low AC Report Delay

Note: You must select 6-12 hours in UL central station installations or 15-30 in UL remote signaling installations.

You can adjust the number of hours before a Low AC report will be sent to the central station.

To program low AC report delay, follow these steps:

Note: Steps continued from step 6 of Section 7.5.6.1.

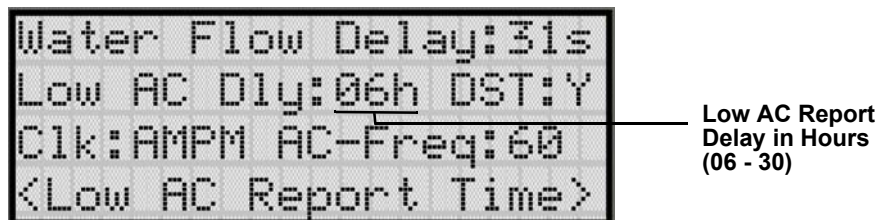

Figure 7-17 Low AC Report Delay Programming Screen

7. Enter the number of hours before a low AC report will be sent to the central station, then press . Refer to Figure 7-20.

7.5.4.3 Automatic Daylight Savings Adjustment

The control panel has an automatic DST (daylight savings time) adjustment feature. If this feature is enabled, the system clock will switch to DST on the first Sunday in April at 2:00 a.m. The system clock will revert to standard time on the last Sunday in October at 2:00 a.m.

To enable or disable DST adjustment continue programming from step 7 above:

8. Select Y (enabled) or N (disabled) by pressing the or arrow, then press .

7.5.4.4 Clock Display Format (AM/PM or Military)

To change the system clock display format, continue programming from step 8 above:

9. Select AMPM (for AM/Pm display format) or MIL (for military or 24 hr display format) by pressing the or arrow, then press .

7.5.4.5 Change AC Line Frequency

The panel's AC line frequency is selectable for 60 Hz, or Neither. AC Frequency feature dictates how the control panel will calculate time based on the AC line frequency used in the installation site. The "Neither" option can be used in areas where the AC line frequency is not dependable and you want the panel to calculate time from the internal crystal. The internal crystal is not as accurate as the AC power source and 60 Hz should normally be selected. The panel defaults to the 60 Hz. selection.



To change the AC line frequency, continue programming from step 9 above:

10. Select 60 or Neither, by pressing the or arrow, then press .



7.5.5 Miscellaneous Options 2

Through this programming option you can turn the strobe synchronization during silence feature On or Off, and select the control panel to report events by zone or by point.

To edit miscellaneous options 2:

1. Press  or  to display the main menu.
2. Enter the installer code if requested.
3. Select  for Program Menu.





```
Display reads:           Initializing
                       Please wait . . .
```

4. Select  for System Options.
5. Select  for Miscellaneous Options 2.

7.5.5.1 Synchronize Strobes Active During Silence

When "SYNC Strbs w/ Sil:" is Selected as Y (Yes) then strobes will continue to flash when the system is silenced and will stop flashing when the system is reset.





Note: The "SYNC Strbs w/ Sil:" only functions with outputs that use a synchronized output pattern.

6. Press the  or  arrow to toggle this selection between Y (Yes) or N (No).
7. Press  or  to make your selection and move to the next programming option.

Note: See Section 7.2.1.4 for more information about Synchronization protocol choices.





7.5.5.2 Auto Display Oldest Event

When this feature is programmed Y (Yes) then the oldest un-acknowledge event will automatically display on the control panel and remote annunciators after there has been no activity on any system touchpad for two minutes.

8. Press the  or  arrow to toggle this selection between Y (Yes) or N (No).
9. Press  or  to make your selection and move to the next programming option.

7.5.5.3 Report by Zone or by Point

When the "Report by" option is set to Zone, then the control panel will report events by zone. If Point is selected then the control panel will report events by point.



10. Press the  or  arrow to toggle this selection between Zone or Point.
11. Then press  or . See Section 9 for reporting codes.

7.5.7 Edit Banner Message



The banner is the message that displays on the panel LCD when the system is normal, that is, when no alarms or troubles exist and no one is currently using system menus. You can create a customized message, which can be up to 40 characters, two lines of 20 characters each.

If you do not create a customized message, the system will use the internal banner. You cannot change the internal banner.

To customizing the banner display message:

1. Press  or  to display the main menu.
2. Enter the installer code if requested.
3. Select  for Program Menu.



Display reads: Initializing
 Please wait . . .

4. Select  for System Options.
5. Select  for Miscellaneous Options.

A screen similar to the one shown in Figure 7-21 will display.







Figure 7-18 Internal Banner Message

6. Press the  or  arrow to select "Custom", then press .

A screen similar to the one shown in Figure 7-22 will display.



Figure 7-19 Custom Banner Edit Screen







7. Select each character of a word by pressing the  or  arrow, then press  to move to the next character.
8. When word or sentence is complete press  to move to line two of the custom banner. Repeat step 7 and 8.

7.6 JumpStart Autoprogramming

IMPORTANT!

JumpStart is intended to be used prior to performing any custom programming. Each time JumpStart is executed, all options will be reset to their default values. Do not run JumpStart after you have configured the system through programming.

To run JumpStart:

1. Press  or  to display the main menu.
2. Enter the installer code if requested.
3. Select  for Program Menu.
Display reads: Initializing
 Please wait . . .
4. Select  for System Options.
5. Press the  or  arrow to select "Yes" from the warning screen.
6. Press .

7.8 Access Codes

Access codes provide the user access to the control panel functions. Each access code can be customized for each user. This allows some users the ability to access programming and other higher level panel functions, while other users may only need access to lower level functions such as performing fire drills, or acknowledging trouble conditions.

Profile 1 is the profile that dictates what functions the Fire Fighter Key has access to. Because this is the profile for a key the user name and the access code can not be edited for this profile.



Profile 2 is the profile for the installer and is referred to as the "Installer Code". This profile's user name and panel functions can not be edited.

Table 7-8 lists the panel functions that can be selected for each user profile.

Table 7-8: User Profile Selectable Panel Functions

Type of Function	Selectable Functions
Panel Operations	System Reset
	System Silence
	System Event Acknowledge
Panel Menus	System Tests
	Fire Drill Menu
	Indicator Test
	Walk Test no Report
	Walk Test with Report
	Dialer Test
	Clear History Buffer
	Point Functions
	Disable/Enable Point
	Point Status
	Set SLC Device Address
	SLC Device Locator
	SLC Multi-Device Locator
	I/O Point Control
	Event History
	Set Time & Date
	Printer Options
	Event Logging
	Print Event History
	Print Detector Status
	Print System Configuration
	Reset Dialer
	Program Menu
System Information	
Upload/Download	



To change an access code:

1. Press  or  to display the main menu.
2. Enter the installer code if requested.
3. Select  for Program Menu.

Display reads: Initializing
 Please wait . . .

4. Select  for System Options.

Display reads: Select Profile 01
 Fire Fighter's Key





5. Select the access code you wish to edit by pressing the  or  arrow.
6. Then press .

7.8.1 Profile Edit Menu



From the Profile Edit Menu you can change the users name, access code, and the panel functions that the user will have access to with their code.

Note: Profile 1 (Fire Fighter's Key) the user name and access code can not be edited. Profile 2 (Installer) the user name and panel functions can not be edited.







7.8.1.1 Edit Name

7. Select each character of a word by pressing the  or  arrow, then press  to move to the next character.
8. Repeat step 7 until user name is complete.
9. Then press  to finish.

7.8.1.2 Edit Access Code

10. Enter new access code (minimum of 4 digits, maximum of 7 digit)
11. Press .
12. Enter code again.
13. Press .

7.8.1.3 Panel Functions

14. Press the  or  arrow to move through the list of available functions.
15. Then press  to move to Y (yes) or N (no) selection column.
16. Press the  or  arrow to select Y or N.
17. Press .
18. Repeat steps 14 through 17 until user profile is complete.

Section 8

System Operation

Operation of the control panel is simple. Menus guide you step-by-step through operations. This section of the manual is an overview of the operation menus. Please read this entire section carefully before operating the panel.

Press  to view Main Menu: Select the desired menu option. Enter your access code if prompted.

Note: See Section 7.8 for information on how to modify user access code profiles.

Default Codes:

User Code (factory-programmed as 1111).

Installer Code (factory-programmed as 123456).

8.1 Annunciator Description

Figure 10-1 shows the annunciator that is part of the control panel board assembly.

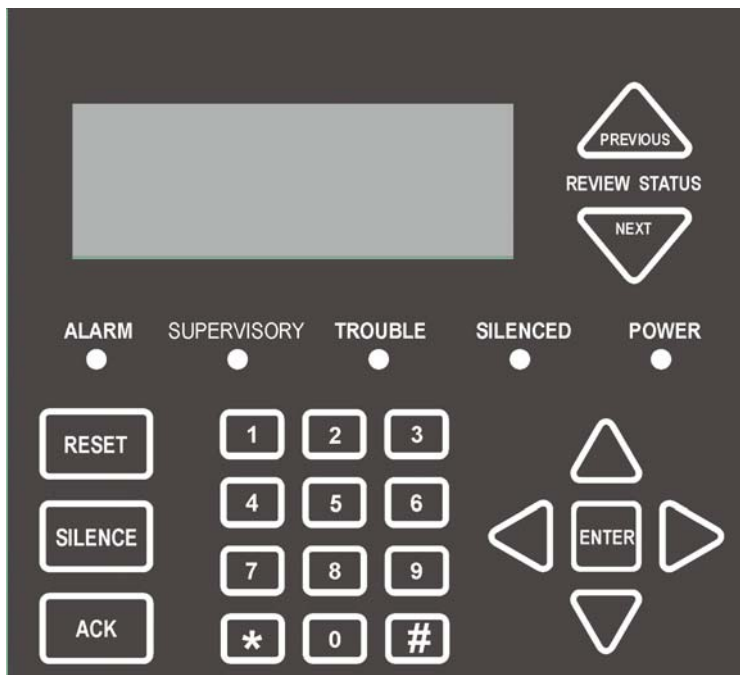

Figure 8-1 Control Panel Annunciator

8.1.1 LCD Displays

The control panel LCD displays system messages, annunciates alarms, supervisories and troubles; provides status information; and prompts for input. These messages can be up to 80 characters, displaying over four lines of 20 characters each. Annunciator keys beep when they are pressed.



8.1.2 Banner

The banner is the message that displays on the control panel when the system is in normal mode (no alarm or trouble condition exists and menus are not in use). You can create a customized message that will display instead of the internal (default) message. See Section 7.5.9 for information on customizing the banner.



Figure 8-2 Banner Display Examples

8.2 Menu System

The control panel is easy to operate from Main Menu. To view the Main Menu press the  or  button on the control panel or remote annunciator, then turn the firefighter's key clockwise or enter your access code. The Main Menu will appear as shown in Section 8.2.1. Select the desired option. If you have entered a code or firefighter's key does not have access to the menu item you have selected the following display message will appear:









```
-Access denied.-
Entered PIN does not
allow access to this
function.
```

You must enter an access code with the correct profile settings to gain access to that menu item.





The control panel supports up to 20 access codes. The profile for each access code (or user) can be modified through the programming menu option (see Section 7.8 for access code programming).

8.2.1 Main Menu Overview

The chart below is a brief overview of the Main Menu. These options are described in greater detail throughout this section of the manual.





Main Menu Options	Description
 System Tests	From here both menus can access Fire Drill and Indicator Test.
 Point Functions	From here both menus can enable / disable points.
 Event History	Display event history on the LCD. See Section 8.3.3 for more information.
 Set Time and Date	Set time and date for the system.
 Printer Options	Options for controlling a printer if attached to the system. If a printer is used, the Model 5824 Serial/Parallel Interface must be used.
 Reset Dialer	Cancel any attempt to call the central station. Any calls awaiting additional attempts will be aborted.
 Program Menu	Brings up a set of menus for programming the panel, including changing access codes. These options are described in detail in Section 7.
 System Info	View system information, including model and serial numbers and revision number and date.
 Up/Download	Initiate communication from the panel site between the panel and a computer running the Silent Knight Software Suite.

8.2.2 Using the Menus

To move through the menus:	Use  and  to move through the options in a menu. Use  to move to a previous menu.
To select an option:	Enter the number of the option. ñORñ Press  (Enter key) if the option appears at the top of the menu (= symbol displays after the option number in this case).

8.3 Basic Operation

8.3.1 Setting Time and Date

1. From the Main Menu, select  for Set Date and Time.
2. Make changes in the fields on the screen. Use  (right arrow) to move through the fields. Use the  and  to select options in the fields.
3. When the date and time are correct, press .

8.3.2 Disable / Enable a Point

1. From the Main Menu, select **2** for Point Functions.
2. Select **1** for Disable/Enable Point. A list of modules displays.
3. Use **▼** and **▲** to move through the list. Press **ENTER** to select the module where the point you want to disable/enable is located. A description of the point should display. The fourth line of the screen should show "NORMAL" (meaning that the point is currently enabled) or "DISABLED" (the point is currently disabled). Press **ENTER** to toggle between NORMAL and DISABLE.

8.3.3 View Event History

Use the View Event History feature to display events on LCD. From the Main Menu, press **3** to select Event History. Events will begin displaying with most recent events first.

The panel can store up to 1000 events. When it reaches its 1000-event capacity, it begins deleting, starting with the oldest events.

If a printer is attached to the system (via a Module 5824 Serial/Parallel Interface), you can print event history (see Section 8.3.16).

The Silent Knight Software Suite (SKSS) can be used to retain more than 1000 events and to create event history reports.

8.3.3.1 To clear the event history

From the Installer menu select **1** for System Tests. From the test menu select **6** Clear History Buffer.

8.3.4 Conduct a Fire Drill

1. From the Main Menu, press **1** for System Tests.
2. Press **1** for Fire Drill. You will be prompted to press **ENTER**.
3. The drill will begin immediately after you press **ENTER**.
4. Press any key to end the drill. (If you do not press any key to end the fire drill manually, it will time out automatically after one hour.)

If a fire drill switch has been installed, activating the switch will begin the drill; deactivating the switch will end the drill.

8.3.5 Conduct an Indicator Test

The indicator test checks the annunciator LEDs, PZT, and LCD display.

1. From the Main Menu, press **[1]** for System Tests.
2. Press **[2]** for Indicator Test. The system turns on each LED several times, beeping the PZT as it does so. At the same time it scrolls each available character across the LCD. A problem is indicated if any of the following occurs:
 - i An LED does not turn on;
 - ii You do not hear a beep;
 - iii All four lines of the LCD are not full.

This test takes approximately 15 seconds to complete. You can press any key to end manually while the test is still in progress. When the test ends, you will be returned to the <Test Menu>.

8.3.6 Conduct a Walk Test

1. From the Main Menu, press **[1]** for System Tests.

IMPORTANT!

If any alarm verification zones are being used, the user will be asked if they wish to disable alarm verification during walk test. This occurs for either walk test option.

2. Select **[3]** for Walk Test-No Rpt. The LCD will display "WALK TEST STOPPED" on Line 1 and "ENTER = start test" on Line 2. If you select this option, central station reporting will be disabled while the test is in progress.

Select **[4]** for Walk Test-with Rpt. The LCD will display "WALK TEST STOPPED" on Line 1 and "ENTER = start test" on Line 2. If you select this option, central station reporting will occur as normal during the walk test.

The panel generates a TEST report to the central station when the walk test begins. During a walk test, the panel's normal fire alarm function is completely disabled, placing the panel in a local trouble condition. All zones respond as 1-Count zones (respond when a single detector is in alarm) during a walk test. Each alarm initiated during the walk test will be reported and stored in the event history buffer.

3. Enter the number of seconds you want the notification appliance circuits to sound. From 6 to 180 seconds.
4. Press **[ENTER]** to end the walk test. The system will reset. The panel will send a "TEST RESTORE" report to the central station.

If you do not end the walk test manually within 60 minutes, it will end automatically. If an alarm or pre-alarm condition is occurring in the system, you will not be able to enter the walk test.

Note: the panel does not do a full 30 second reset on resettable power outputs. As soon as the device is back to normal, the panel is ready to go to the next device.

8.3.7 Conduct a Dialer Test

1. From the Main Menu, press **1** for System Tests.
2. Select **5** for Dialer Test. The screen will display "Manual dialer test started". When the test is completed, you will be returned to the <Test Menu>.

8.3.8 Silence alarms or troubles

Press **SILENCE** and enter your code or rotate the key at the prompt. If an external silence switch has been installed, activating the switch will silence alarms or troubles. If you are already using system menus when you press **SILENCE**, you will not need to enter your code or rotate the key.

Note: Alarm and trouble signals that have been silenced but the detector remains un-restored will un-silence every 24 hours until it is restored.

8.3.9 Reset alarms

Press **RESET** and enter your code or rotate the key at the prompt. If an external reset switch has been installed, activating the switch will reset alarms. If you are already using system menus when you press **RESET**, you will not need to enter your code or rotate the key.

8.3.10 Check Detector Through Point Status

The control panel constantly monitors smoke detectors to ensure that sensitivity levels are in compliance with NFPA 72.

If sensitivity for a detector is not in compliance, the panel goes into trouble, generating a CAL TRBLE condition. A detector enters a CAL MAINT state to indicate that it is approaching an out of compliance condition (but is currently still in compliance).

When a CAL TRBLE condition occurs, the central station receives a detector trouble report (i373i + Zone # for Contact ID format; iFTi + Zone # in SIA format).

To check sensitivity for an individual detector, follow the steps below. Section 8.3.16 provides instructions for printing the status of all detectors in the system.

1. From the Main Menu, press **2** for Point Functions.
2. Press **2** for Point Status.
3. Select the module where the point you want to check is located.
4. Enter the number of the point you want to check and press **ENTER**.

5. A screen similar to those shown in Figure 8-3 will display.

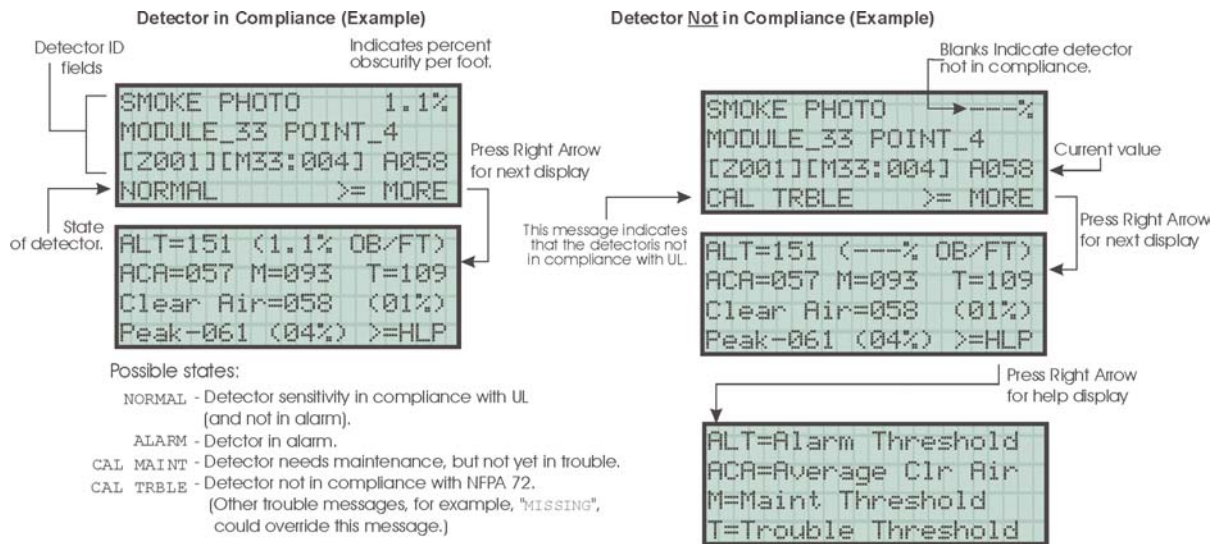

Figure 8-3 Checking Detector Sensitivity Compliance

If a printer is attached to the system (via a Module 5824 Serial/Parallel Interface), you can print detector status (see Section 8.3.16).

8.3.11 View Status of a Point

1. From the Main Menu, select **2** for Point Status.
2. From the list that displays, press **ENTER** to select the module where this point is located. The screen that displays will show you if the point has a trouble and will provide sensitivity compliance information. (See Section 8.3.10 for complete information about detector sensitivity compliance.)

8.3.12 View Alarms or Troubles

When the system is in alarm or trouble, you can press **▼** to view the location of an alarm or trouble. See Section 8.3.12 for more information.

8.3.13 View System Information

Press **8** from the Main Menu to view the panel model and serial number and system version number and date. The information displays for several seconds then returns to the main menu.

8.3.14 Reset dialer

From the Main Menu, select **6**. The LCD will display *Dialer reset in progress...* You will be returned to the Main Menu when the reset is completed.

8.3.15 Communicating with a Remote Computer

An installer at the panel site can initiate communications between the panel and a computer running the Silent Knight Software Suite. You can use this feature to upload a panel configuration. For example, if you have made programming changes to an installation on site using an annunciator, you can send your changes to the computer, so that the central station will have the latest data about the installation. To initiate communication, follow the steps below.

1. From the Main Menu, select **9** for Up/Download.
2. From the next screen that displays, select the communication device. Options are:

1 = Internal Modem	If you select this option, you will use the panel's built-in modem to call the panel.
2 = RS232 connection	If you select this option, the panel and a computer are both on-site connected via a 9-pin straight-through serial cable.

3. If you are using the panel's internal modem to communicate, you will be prompted to enter a phone number. If you are communicating via the RS232 connection, a phone number is not needed and this step will be skipped.

If the phone number you will be calling is already displayed, press **ENTER**. Continue with Step 4.

If the phone number you will be calling is not already displayed, enter the number and press **ENTER**. A phone number can be up to 24 digits long and can contain the following special characters.

#	Pound (or number) key on the telephone
*	Star key on the telephone
,	Comma (character for 2-second pause)

Use the number buttons on the annunciator or the up- and down-arrow keys to select special characters. Characters begin displaying after $\hat{i}9\hat{i}$.

4. You will be prompted to enter an account number. If the account number you want to use is already displayed, just press **ENTER** to begin communication.

If the account number displayed is not the correct one, enter the account number and press **ENTER** to begin communication.

5. The panel will attempt to communicate with the computer. If communication was established, the upload task you created will be placed on the Downloading Software job queue, awaiting processing. When processing is completed, an \hat{i} Unsolicited Upload \hat{i} task will appear in the queue.

8.3.16 Working with a Printer

If you are using the Model 5824 Serial/Parallel Interface, several printing options are available. See Section 4.6 for information about installing the 5824.

1. From the Main Menu, select **5** Printer Options.
2. From the next screen, select the 5824 module where the printer is connected.
3. If the printer is not currently busy printing another report, a screen with the following options will be available. If the printer is busy, a message will display. You can press **1** to cancel the current print job. These options will then display.

Table 8-1: Printer Options

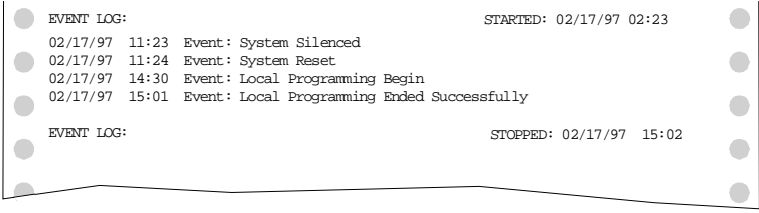
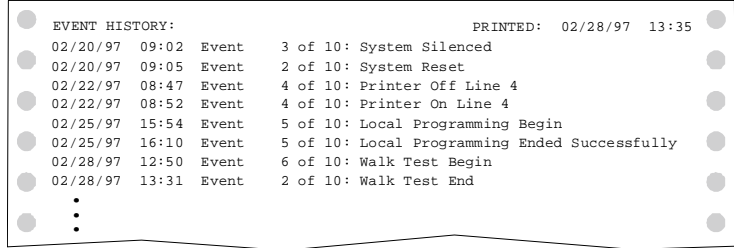
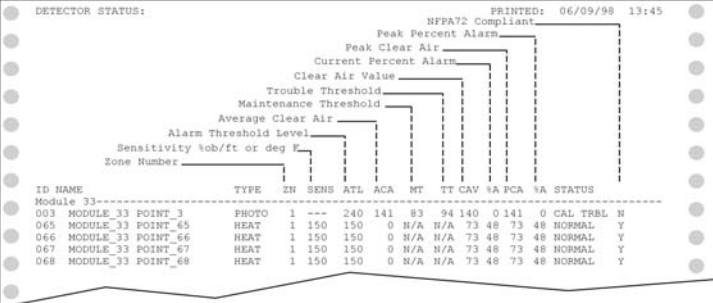
<p>1 = Event Logging</p>	<p>Enables event logging, which causes the printer to continuously print events as they occur. The date/time will print in 24-hour military format. Once event logging is enabled, it will remain enabled until canceled by the installer. If you need to disable event logging, return to this option and press 1 to disable.</p>
<p>Sample Event Log</p>	 <pre> EVENT LOG: STARTED: 02/17/97 02:23 02/17/97 11:23 Event : System Silenced 02/17/97 11:24 Event : System Reset 02/17/97 14:30 Event : Local Programming Begin 02/17/97 15:01 Event : Local Programming Ended Successfully EVENT LOG: STOPPED: 02/17/97 15:02 </pre>
<p>2 = Print Event History</p>	<p>Prints the up-to-1000 events currently stored in the panel's event history buffer. Events print starting with the newest. The date and time printed will be when the event actually occurred and will print in 24-hour military format.</p>
<p>Sample Event History Print-Out</p>	 <pre> EVENT HISTORY: PRINTED: 02/28/97 13:35 02/20/97 09:02 Event 3 of 10: System Silenced 02/20/97 09:05 Event 2 of 10: System Reset 02/22/97 08:47 Event 4 of 10: Printer Off Line 4 02/22/97 08:52 Event 4 of 10: Printer On Line 4 02/25/97 15:54 Event 5 of 10: Local Programming Begin 02/25/97 16:10 Event 5 of 10: Local Programming Ended Successfully 02/28/97 12:50 Event 6 of 10: Walk Test Begin 02/28/97 13:31 Event 2 of 10: Walk Test End : : : </pre>
<p>3 = Print Detector Status</p>	<p>Prints the current status of all detectors in the system. This is a method for finding out if any detectors are out of NFPA2 compliance or any detectors need maintenance (are approaching an out of compliance condition).</p>
<p>Sample Detector Status Print-Out</p>	 <pre> DETECTOR STATUS: PRINTED: 06/09/98 13:45 Peak NFPA2 Compliant Peak Percent Alarm Peak Clear Air Current Percent Alarm Clear Air Value Trouble Threshold Maintenance Threshold Average Clear Air Alarm Threshold Level Sensitivity sob/ft or deg F Zone Number ID NAME----- TYPE ZN SENS ATL ACA NT TT CAV SA PCA SA STATUS Module 33----- 003 MODULE_33 POINT_3 PHOTO 1 --- 240 141 83 94 140 0 141 0 CAL TRBL N 065 MODULE_33 POINT_65 HEAT 1 150 150 0 N/A N/A 73 48 73 48 NORMAL Y 066 MODULE_33 POINT_66 HEAT 1 150 150 0 N/A N/A 73 48 73 48 NORMAL Y 067 MODULE_33 POINT_67 HEAT 1 150 150 0 N/A N/A 73 48 73 48 NORMAL Y 068 MODULE_33 POINT_68 HEAT 1 150 150 0 N/A N/A 73 48 73 48 NORMAL Y </pre>

Note: Detector status can also be viewed and printed using the SKSS or SKSS Facility Management Software.

8.4 Operation Mode Behavior

The control panel can be in one of seven conditions at any given moment: Normal, Alarm, Prealarm, Supervisory, Trouble, Silenced, and Reset. Table 8-2 describes the behavior of the panel in each of these modes.

Table 8-2: Operation Modes of FACP











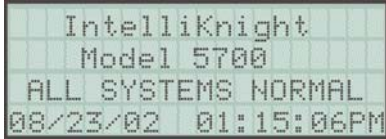
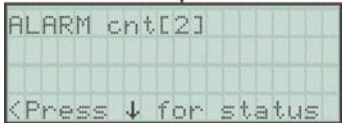







Operation Mode	Occurs When	System Behavior	In This Mode You Can
Normal	No alarm or trouble condition exists and menus are not in use.	<p>SYSTEM POWER LED is on.</p> <p>The All Systems Normal display indicates that the system is in normal mode.</p>  <p>The current date and time display on the last line of the LCD.</p>	Enter the appropriate code, or rotate the key to activate the Main Menu.
Alarm	A smoke detector goes into alarm or a pull station is activated.	<p>The dialer seizes control of the phone line and calls the central station.</p> <p>The on-board annunciator sounds a loud, steady beep (any notification devices attached to the system will also sound).</p> <p>GENERAL ALARM LED flashes.</p> <p>The LCD displays a screen similar to this one.</p>  <p>Count of alarms in the system. In this example there are 2.</p> <p>Press the down arrow to view the type and location of alarm. (Message alternates with the date/time display.)</p>	<p>Press the down arrow to view the alarm. A screen similar to this one displays.</p>  <p>Module and Point name, Device type, Zone name</p> <p>Shows which event is currently being displayed. In this example, there are 5 alarms, the third is being displayed.</p> <p>Press  and enter an access code (or activate the key) to silence the annunciator (and any notification devices attached to the system).</p> <p>When the alarm condition clears, press  and enter a code (or activate the key) to restore the panel to normal.</p>
Supervisory	The system detects a supervisory condition.	<p>The dialer seizes control of the phone line and calls the central station.</p> <p>The on-board annunciator sounds a loud, pulsing beep in the sequence one second on, one second off.</p> <p>SUPERVISORY LED flashes.</p> <p>The LCD displays a screen similar to this one.</p>  <p>Count of supervisories in the system. In this example there is 1.</p> <p>Press the down arrow to view the type and location of alarm. (Message alternates with the date/time display.)</p>	<p>Press  (down arrow) to view the supervisory condition. A screen similar to this one displays.</p>  <p>Module and Point name, Device type, Zone name</p> <p>Shows which event is currently being displayed.</p> <p>Press  and enter an access code (or activate the key) to silence the annunciator.</p> <p>Once the supervisory condition has been corrected, the system will restore itself automatically.</p>

Table 8-2: Operation Modes of FACP

Operation Mode	Occurs When	System Behavior	In This Mode You Can
Trouble	A system trouble condition occurs.	<p>The dialer seizes control of the phone line and calls the central station.</p> <p>The on-board annunciator sounds a loud, pulsing beep in the sequence one second on, nine seconds off.</p> <p>SYSTEM TROUBLE LED flashes.</p> <p>The LCD displays a screen similar to this one.</p> <p>Count of troubles in the system In this example there are 3.</p>  <p>Press the down arrow to view the type and location of trouble condition. (This message alternates with the date / time display.)</p>	<p>Press  (down arrow) to view the trouble. A screen similar to this one displays.</p>  <p>Press  and enter an access code (or activate the key) to silence the annunciator.</p> <p>Once the trouble condition has been fixed, the system will restore itself automatically.</p>
Prealarm	A single detector trips in a 2-Count zone. (2-Count means two detectors must trip before an alarm is reported.)	<p>Touchpad PZT beeps.</p> <p>The LCD displays a screen similar to this one.</p> <p>Count of alarms in the system In this example there are 2.</p>  <p>Press the down arrow to view the type and location of alarm. (Message alternates with the date/time display.)</p>	<p>Press  (down arrow) to view the prealarm. A screen similar to this one displays.</p>  <p>All system operations are available in this mode.</p>
Reset	The  button is pressed followed by a valid code or rotation of the key.	All LEDs are on briefly then the LCD displays "ALARM RESET IN PROGRESS". If the reset process completes normally, the date and time normal mode screen displays.	Menus are not available during the reset process.
Silenced	An alarm or trouble condition has been silenced but still exists. To silence alarms and troubles, press  followed by the Installer or User Code or rotate the key.	SYSTEM SILENCE LED is on. SYSTEM TROUBLE, SUPERVISORY or GENERAL ALARM LED (depending on condition) is on. The annunciator (and any notification devices attached to the system) will be silenced.	Press  (down arrow) to view the location of the alarm or trouble. When the condition no longer exists, the SYSTEM SILENCED and SYSTEM TROUBLE LED, SUPERVISORY or GENERAL ALARM LEDs turn off.

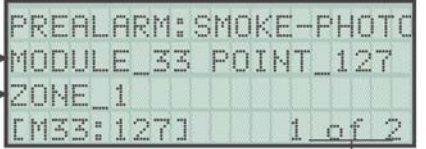
8.5 Releasing Operations

This control panel supports two types of releasing, Double Interlock Zone, and Single Interlock Zone. The Double Interlock Zone operation requires an interlock switch input in the system, and the Single Interlock does not. An interlock switch is typically a dry-contact pressure switch.

Important!

These releasing functions can only be done if the system has a 5496 intelligent power module included.

When a Single or Double Interlock Zone releasing is selected the system will automatically default the 5496 Intelligent Power Module in the following system parameters:

Note: The defaults created can be modified through programming if desired.

- i Output Group 2 is created. Output Group 2 will be defaulted as an "Alarm" output group for all releasing zones. NAC [01:001] is assigned to Output Group 2.
- i Output Group 3 is created. Output Group 3 will be defaulted as an "Pre-Alert" output group for all releasing zones. NAC [01:002] is assigned to Output Group 3.
- i Output Group 4 is created. Output Group 4 will be defaulted as a "Release" output group for all releasing zones. NAC circuit [01:003] is assigned to Output Group 4.

Note: The installer must define which input points will be used for detectors, manual release switches, or interlock/pressure switches.

Manufacturer	Part Number	Rating
Asco	T8210A107	24 VDC
	8210G207	24 VDC

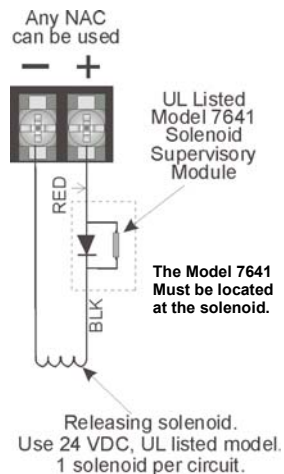

Figure 8-4 Wiring Configuration for Solenoid

Important!

Detectors must be installed at 0.7 times the linear spacing as described in NFPA 72, Chapter 2.

8.5.1 Single Interlock Zone Releasing

A single interlock zone utilizes a minimum of two addressable detectors, and a designated manual release switch.

Important!
Only addressable detectors can be used. No conventional detectors can be used.
Each Single Interlock Zone input requires at least one manual release switch.

Conditions Required for an Pre-Alert Output Activation

If any single addressable detector is activated, the "Pre-Alert" output will activate. This alerts the user that the initial stages required for a release condition are present. (Also refer to Table 8-3.)

Conditions required for an General Alarm and Release Output Activation

If two or more addressable detectors, or a manual release switch activate, the "Alarm" and the "Release" outputs will activate. (Also refer to Table 8-3.)

Table 8-3: Input Conditions and Output Results

Inputs	Output Results							
1st Addressable Detector		✓		✓		✓		✓
2nd Addressable Detector			✓	✓			✓	✓
Manual Release Station					✓	✓	✓	✓
	Normal	Pre-Alert	Pre-Alert	Release and General Alarm	Release and General Alarm	Release and General Alarm	Release and General Alarm	Release and General Alarm

8.5.2 Double Interlock Zone Releasing

A Double Interlock Zone uses a minimum of two Addressable detectors, a designated manual release switch, and an interlock switch input. An interlock switch is typically a dry-contact pressure switch and will be referred to as an interlock/pressure switch in this document.

Important!
Only addressable detectors can be used. No conventional detectors can be used.
Each Single Interlock Zone input requires at least one manual release switch.
Each Double Interlock Zone input requires at least one Interlock/pressure switch

Conditions Required for a Pre-Alert Output Activation

If any single addressable detector is activated, the "Pre-Alert" output will activate. This alerts the user that the initial stages required for a release condition are present. (Also refer to Table 8-3.)

Conditions Required for a General Alarm Output Activation

If two addressable detectors, a manual release switch is activated, or an interlock switch is active, the "Pre-Alert", and "General Alarm" outputs will activate.

Conditions Required for a Release Output Activation

Any release requires the activation of an interlock switch, and either a manual release switch or 2 activated addressable detectors. When these conditions are met, the "Release" and "General Alarm" outputs will activate, and the "Alert" outputs will deactivate.

Inputs	Output Results															
1st Addressable Detector		✓		✓		✓		✓		✓		✓		✓		✓
2nd Addressable Detector			✓	✓			✓	✓			✓	✓			✓	✓
Manual Release Station					✓	✓	✓	✓					✓	✓	✓	✓
Interlock/Pressure Switch									✓	✓	✓	✓	✓	✓	✓	✓
Normal																
Pre-Alert																
Pre-Alert																
Pre-Alert and General Alarm																
Pre-Alert and General Alarm																
Pre-Alert and General Alarm																
Pre-Alert and General Alarm																
Pre-Alert and General Alarm																
Pre-Alert and General Alarm																
Pre-Alert and General Alarm																
Pre-Alert and General Alarm																
Release and General Alarm																
Release and General Alarm																
Release and General Alarm																
Release and General Alarm																
Release and General Alarm																

Section 9

Reporting

This section lists receivers that are compatible with this control panel, and the reporting codes sent by the control panel for SIA, SIA20 and Contact ID formats.

9.1 Receivers Compatible with the Control Panel

Table 11-1 shows receivers compatible with the control panel.

Table 9-1: Receivers Compatible with the Control Panel

Manufacturer	Model	Format
Silent Knight	Model 9800	SIA and Contact ID
	Model 9000 (SIA formats)	SIA
Ademco	Model 685 (Contact ID)	Contact ID
Sur-Gard	SG-MLR2-DG (V. 1.64 or higher)	SIA and Contact ID
Osborne Hoffman	Quickalert	SIA and Contact ID

Table 9-2: Reporting Codes for SIA and Contact ID Reporting Formats

Event Description	Event Family	"Event Classification (System, Zone, or Point)"	SIA/SIA 20 Reporting			Contact ID			
			Module ID# (if any)	SIA Event Code	Parameter (if any)	Qualifier	Event Code	Group #	Contact #
System Events	Note: System events are reported when either "Report by Point" or "Report by Zone" is selected								
AC power restore	Trouble	System Event		AR		3	301	00	000
AC power lost	Trouble	System Event		AT		1	301	00	000
SBUS expander trouble restore	Trouble	System Event		ER	Exp. ID	3	330	00	Exp ID
SBUS Class A supervision restore	Trouble	System Event		ER	Exp. ID	3	330	00	Exp ID
Short circuit removed from SLC communication loop	Trouble	System Event		ER	Exp. ID	3	330	00	Exp ID
SLC Class A supervision restored	Trouble	System Event		ER	Exp. ID	3	330	00	Exp ID
SBUS expander trouble	Trouble	System Event		ET	Exp. ID	1	330	00	Exp ID
SBUS Class A supervision lost	Trouble	System Event		ET	Exp. ID	1	330	00	Exp ID
Short circuit detected on SLC communication loop	Trouble	System Event		ET	Exp. ID	1	330	00	Exp ID
SLC Class A supervision lost	Trouble	System Event		ET	Exp. ID	1	330	00	Exp ID
Fire drill has begun	Test	System Event		FI		1	604	00	000
Fire drill ended	Test	System Event		FK		3	604	00	000
Panel date has been changed	Trouble	System Event		JD		1	625	00	000
Panel time has been changed	Trouble	System Event		JT		1	625	00	000
Local programming begin	Trouble	System Event		LB		1	627	00	000
Phone line 1 trouble restore	Trouble	System Event		LR	1	3	351	00	000
Phone line 2 trouble restore	Trouble	System Event		LR	2	3	352	00	000
Local programming ended normally	Trouble	System Event		LS		3	306	00	000
Phone line 1 trouble detected	Trouble	System Event		LT	1	1	351	00	000
Phone line 2 trouble detected	Trouble	System Event		LT	2	1	352	00	000
Local programming aborted or ended with errors	Trouble	System Event		LU		1	306	00	000

Table 9-2: Reporting Codes for SIA and Contact ID Reporting Formats

Event Description	Event Family	"Event Classification (System, Zone, or Point)"	SIA/SIA 20 Reporting			Contact ID			
			Module ID# (if any)	SIA Event Code	Parameter (if any)	Qualifier	Event Code	Group #	Contact #
Periodic test event	Test	System Event		RP	0 = Sys. Normal 1 = Sys. not-Norm	1	602	00	0 = Sys. Normal 1 = Sys. not-Norm
Initial power up	Trouble	System Event		RR		3	305	00	000
Remote programming ended normally	Trouble	System Event		RS		3	412	00	000
Unable to report to an account	Trouble	System Event		RT	Acct #	1	354	00	Acct #
Remote programming aborted or ended with errors	Trouble	System Event		RU		1	413	00	000
User has initiated dialer test	Test	System Event		RX	Channel #	1	601	00	Channel #
Walk test end	Test	System Event		TE		3	551	00	000
SLC address programming ended; system has been re-enabled.	Test	System Event		TE		3	551	00	000
Walk test begin	Test	System Event		TS		1	551	00	00
SLC address programming started; system has been shut down.	Test	System Event		TS		1	551	00	00
Printer paper restore	Trouble	System Event		VI	Exp ID	3	335	00	Exp ID
Printer is out of paper	Trouble	System Event		VO	Exp ID	1	335	00	Exp ID
Printer back online	Trouble	System Event		VY	Exp ID	3	336	00	Exp ID
Printer offline	Trouble	System Event		VZ	Exp ID	1	336	00	Exp ID
Auto dialer test communication trouble	Trouble	System Event		YC	Line #	1	354	00	Line #
Report to an account successful	Trouble	System Event		YK	Acct #	3	354	00	Acct #
Auto dialer test communication trouble restore	Trouble	System Event		YK	Line #	3	354	00	Line #
Ground fault condition detected	Trouble	System Event		YP	Exp. ID	1	300	00	Exp ID
Ground fault condition restore	Trouble	System Event		YQ	Exp. ID	3	300	00	Exp ID
Battery voltage restore	Trouble	System Event		YR	Exp. ID	3	302	00	Exp ID
Battery voltage low	Trouble	System Event		YT	Exp. ID	1	302	00	Exp ID
Zone Events	Note: Zone events are reported only when "Report by Zone" is selected. See Section 7.5.7.								
SLC LED Module trouble restore	Trouble	Zone Event		ER	0000	3	330	00	Exp ID
SLC LED Module trouble	Trouble	Zone Event		ET	0000	1	330	00	Exp ID
Manual pull switch alarm	Alarm	Zone Event		FA	Zone	1	110	00	Zone
Detector alarm	Alarm	Zone Event		FA	Zone	1	110	00	Zone
Manual pull switch alarm restore	Restore	Zone Event		FH	Zone	3	110	00	Zone
Detector alarm restore	Restore	Zone Event		FH	Zone	3	110	00	Zone
Manual pull switch trouble restore	Trouble	Zone Event		FJ	Zone	3	373	00	Zone
Detector trouble restore	Trouble	Zone Event		FJ	Zone	3	373	00	Zone
Positive Alarm Sequence acknowledge switch trouble restore	Trouble	Zone Event		FJ	Zone	3	373	00	Zone
Auxiliary power trouble restore	Trouble	Zone Event		FJ	0000	3	373	00	00
Notification output trouble restore	Trouble	Zone Event		FJ	1000+Group #	3	373	01	Group #
Manual pull switch trouble	Trouble	Zone Event		FT	Zone	1	373	00	Zone
Detector trouble	Trouble	Zone Event		FT	Zone	1	373	00	Zone
Positive Alarm Sequence acknowledge switch trouble	Trouble	Zone Event		FT	Zone	1	373	00	Zone
Auxiliary power trouble	Trouble	Zone Event		FT	0000	1	373	00	000
Notification trouble	Trouble	Zone Event		FT	1000+Group #	1	373	01	Group #
User initiated a system reset	Reset	Zone Event		OR		1	400	00	000
Water flow switch alarm	Alarm	Zone Event		SA	Zone	1	113	00	Zone
Water flow switch alarm restore	Restore	Zone Event		SH	Zone	3	113	00	Zone
Water flow switch trouble restore	Trouble	Zone Event		SJ	Zone	3	370	00	Zone
Supervisory/Tamper switch trouble restore	Trouble	Zone Event		SJ	Zone	3	370	00	Zone
Supervisory condition restore	Trouble	Zone Event		SR	Zone	3	203	00	Zone

Table 9-2: Reporting Codes for SIA and Contact ID Reporting Formats

Event Description	Event Family	"Event Classification (System, Zone, or Point)"	SIA/SIA 20 Reporting			Contact ID			
			Module ID# (if any)	SIA Event Code	Parameter (if any)	Qualifier	Event Code	Group #	Contact #
Supervisory condition	Trouble	Zone Event		SS	Zone	1	203	00	Zone
Water flow switch trouble	Trouble	Zone Event		ST	Zone	1	370	00	Zone
Supervisory/Tamper switch trouble	Trouble	Zone Event		ST	Zone	1	370	00	Zone
Zone-based AUX1 switch alarm	Alarm	Zone Event		UA	1000+Zone	1	140	01	Zone
Zone-based AUX2 switch alarm	Alarm	Zone Event		UA	2000+Zone	1	140	02	Zone
System-based AUX1 switch alarm	Alarm	Zone Event		UA	1000	1	140	01	000
System-based AUX2 switch alarm	Alarm	Zone Event		UA	2000	1	140	02	000
Zone-based AUX1 switch alarm restore	Restore	Zone Event		UH	1000+Zone	3	140	01	Zone
Zone-based AUX2 switch alarm restore	Restore	Zone Event		UH	2000+Zone	3	140	02	Zone
System-based AUX1 switch alarm restore	Restore	Zone Event		UH	1000	3	140	01	000
System-based AUX2 switch alarm restore	Restore	Zone Event		UH	2000	3	140	02	000
Zone-based AUX1 switch trouble restore	Trouble	Zone Event		UJ	1000+Zone	3	370	01	Zone
Zone-based AUX2 switch trouble restore	Trouble	Zone Event		UJ	2000+Zone	3	370	02	Zone
System-based AUX1 switch trouble restore	Trouble	Zone Event		UJ	1000	3	370	01	000
System-based AUX2 switch trouble restore	Trouble	Zone Event		UJ	2000	3	370	02	000
External Reset/Silence/Fire Drill switch trouble restore	Trouble	Zone Event		UJ	0000	3	370	00	000
Zone-based AUX1 switch trouble	Trouble	Zone Event		UT	1000+Zone	1	370	01	Zone
Zone-based AUX2 switch trouble	Trouble	Zone Event		UT	2000+Zone	1	370	02	Zone
System-based AUX1 switch trouble	Trouble	Zone Event		UT	1000	1	370	01	000
System-based AUX2 switch trouble	Trouble	Zone Event		UT	2000	1	370	02	000
External Reset/Silence/Fire Drill switch trouble	Trouble	Zone Event		UT	0000	1	370	00	000
Point Events	Note: Point events are reported only when "Report by Point" is selected. See Section 7.5.7.								
Manual pull switch alarm	Alarm	Point Event	pi Exp. ID	FA	Pnt #	1	110	Exp. ID	Pnt #
Manual release switch alarm (Water Release Zone)	Alarm	Point Event	pi Exp. ID	FA	Pnt #	1	110	Exp. ID	Pnt #
Interlock switch alarm (Water Release Zone)	Alarm	Point Event	pi Exp. ID	FA	Pnt #	1	110	Exp. ID	Pnt #
Detector alarm	Alarm	Point Event	pi Exp. ID	FA	Pnt #	1	110	Exp. ID	Pnt #
Point disabled	Disable	Point Event	pi Exp. ID	FB	Pnt #	1	571	Exp. ID	Pnt #
Manual pull switch alarm restore	Restore	Point Event	pi Exp. ID	FH	Pnt #	3	110	Exp. ID	Pnt #
Manual release switch alarm restore (Water Release Zone)	Restore	Point Event	pi Exp. ID	FH	Pnt #	1	110	Exp. ID	Pnt #
Interlock switch alarm restore (Water Release Zone)	Restore	Point Event	pi Exp. ID	FH	Pnt #	1	110	Exp. ID	Pnt #
Detector alarm restore	Restore	Point Event	pi Exp. ID	FH	Pnt #	3	110	Exp. ID	Pnt #
Notification output trouble restore	Trouble	Point Event	pi Exp. ID	FJ	Pnt #	3	373	Exp. ID	Pnt #
Manual pull switch trouble restore	Trouble	Point Event	pi Exp. ID	FJ	Pnt #	3	373	Exp. ID	Pnt #
Manual release switch trouble restore (Water Release Zone)	Trouble	Point Event	pi Exp. ID	FJ	Pnt #	1	373	Exp. ID	Pnt #
Interlock switch trouble restore (Water Release Zone)	Trouble	Point Event	pi Exp. ID	FJ	Pnt #	1	373	Exp. ID	Pnt #
Detector trouble restore	Trouble	Point Event	pi Exp. ID	FJ	Pnt #	3	373	Exp. ID	Pnt #
Positive Alarm Sequence acknowledge switch trouble restore	Trouble	Point Event	pi Exp. ID	FJ	Pnt #	3	373	Exp. ID	Pnt #
Aux power trouble restore	Trouble	Point Event	pi Exp. ID	FJ	Pnt #	3	373	Exp. ID	Pnt #
Notification output trouble	Trouble	Point Event	pi Exp. ID	FT	Pnt #	1	373	Exp. ID	Pnt #
Manual pull switch trouble	Trouble	Point Event	pi Exp. ID	FT	Pnt #	1	373	Exp. ID	Pnt #
Manual release switch trouble (Water Release Zone)	Trouble	Point Event	pi Exp. ID	FT	Pnt #	1	373	Exp. ID	Pnt #
Interlock switch trouble restore (Water Release Zone)	Trouble	Point Event	pi Exp. ID	FT	Pnt #	1	373	Exp. ID	Pnt #
Detector trouble	Trouble	Point Event	pi Exp. ID	FT	Pnt #	1	373	Exp. ID	Pnt #
Positive Alarm Sequence acknowledge switch trouble	Trouble	Point Event	pi Exp. ID	FT	Pnt #	1	373	Exp. ID	Pnt #
Auxiliary Power Trouble	Trouble	Point Event	pi Exp. ID	FT	Pnt #	1	373	Exp. ID	Pnt #

Table 9-2: Reporting Codes for SIA and Contact ID Reporting Formats

Event Description	Event Family	"Event Classification (System, Zone, or Point)"	SIA/SIA 20 Reporting			Contact ID			
			Module ID# (if any)	SIA Event Code	Parameter (if any)	Qualifier	Event Code	Group #	Contact #
Point Enabled	Disable	Point Event	pi Exp. ID	FU	Pnt #	3	571	Exp. ID	Pnt #
Water flow switch alarm	Alarm	Point Event	pi Exp. ID	SA	Pnt #	1	113	Exp. ID	Pnt #
Water flow switch disabled	Disable	Point Event	pi Exp. ID	SB	Pnt #	1	570	Exp. ID	Pnt #
Supervisory/Tamper switch disabled	Disable	Point Event	pi Exp. ID	SB	Pnt #	1	570	Exp. ID	Pnt #
Water flow switch alarm restore	Restore	Point Event	pi Exp. ID	SH	Pnt #	3	113	Exp. ID	Pnt #
Water flow switch trouble restore	Trouble	Point Event	pi Exp. ID	SJ	Pnt #	3	203	Exp. ID	Pnt #
Supervisory/Tamper switch trouble restore	Trouble	Point Event	pi Exp. ID	SJ	Pnt #	3	370	Exp. ID	Pnt #
Supervisory condition restore	Trouble	Point Event	pi Exp. ID	SR	Pnt #	3	203	Exp. ID	Pnt #
Supervisory condition	Trouble	Point Event	pi Exp. ID	SS	Pnt #	1	203	Exp. ID	Pnt #
Water flow switch trouble	Trouble	Point Event	pi Exp. ID	ST	Pnt #	1	370	Exp. ID	Pnt #
Supervisory/Tamper switch trouble	Trouble	Point Event	pi Exp. ID	ST	Pnt #	1	370	Exp. ID	Pnt #
Water flow switch re-enabled	Disable	Point Event	pi Exp. ID	SU	Pnt #	3	570	Exp. ID	Pnt #
Supervisory/Tamper switch re-enabled	Disable	Point Event	pi Exp. ID	SU	Pnt #	3	570	Exp. ID	Pnt #
Zone-based AUX1 switch alarm	Alarm	Point Event	pi Exp. ID	UA	Pnt #	1	140	Exp. ID	Pnt #
Zone-based AUX2 switch alarm	Alarm	Point Event	pi Exp. ID	UA	Pnt #	1	140	Exp. ID	Pnt #
System-based AUX1 switch alarm	Alarm	Point Event	pi Exp. ID	UA	Pnt #	1	140	Exp. ID	Pnt #
System-based AUX2 switch alarm	Alarm	Point Event	pi Exp. ID	UA	Pnt #	1	140	Exp. ID	Pnt #
Auxiliary switch input disabled	Disable	Point Event	pi Exp. ID	UB	Pnt #	1	570	Exp. ID	Pnt #
Zone-based AUX1 switch alarm restore	Restore	Point Event	pi Exp. ID	UH	Pnt #	3	140	Exp. ID	Pnt #
Zone-based AUX2 switch alarm restore	Restore	Point Event	pi Exp. ID	UH	Pnt #	3	140	Exp. ID	Pnt #
System-based AUX1 switch alarm restore	Restore	Point Event	pi Exp. ID	UH	Pnt #	3	140	Exp. ID	Pnt #
System-based AUX2 switch alarm restore	Restore	Point Event	pi Exp. ID	UH	Pnt #	3	140	Exp. ID	Pnt #
Zone-based AUX1 switch trouble restore	Trouble	Point Event	pi Exp. ID	UJ	Pnt #	3	370	Exp. ID	Pnt #
Zone-based AUX2 switch trouble restore	Trouble	Point Event	pi Exp. ID	UJ	Pnt #	3	370	Exp. ID	Pnt #
External Reset/Silence/Fire Drill switch trouble restore	Trouble	Point Event	pi Exp. ID	UJ	Pnt #	3	370	Exp. ID	Pnt #
System-based AUX1 switch trouble restore	Trouble	Point Event	pi Exp. ID	UJ	Pnt #	3	370	Exp. ID	Pnt #
System-based AUX2 switch trouble restore	Trouble	Point Event	pi Exp. ID	UJ	Pnt #	3	370	Exp. ID	Pnt #
Zone-based AUX1 switch trouble	Trouble	Point Event	pi Exp. ID	UT	Pnt #	1	370	Exp. ID	Pnt #
Zone-based AUX2 switch trouble	Trouble	Point Event	pi Exp. ID	UT	Pnt #	1	370	Exp. ID	Pnt #
External Reset/Silence/Fire Drill switch trouble	Trouble	Point Event	pi Exp. ID	UT	Pnt #	1	370	Exp. ID	Pnt #
System-based AUX1 switch trouble	Trouble	Point Event	pi Exp. ID	UT	Pnt #	1	370	Exp. ID	Pnt #
System-based AUX2 switch trouble	Trouble	Point Event	pi Exp. ID	UT	Pnt #	1	370	Exp. ID	Pnt #
Auxiliary switch input re-enabled	Disable	Point Event	pi Exp. ID	UU	Pnt #	3	570	Exp. ID	Pnt #
An unexpected SLC device has been detected	Trouble	Point Event	pi Exp. ID	XE	Pnt #	1	300	Exp. ID	Pnt #
An unexpected SLC device has been removed	Trouble	Point Event	pi Exp. ID	XI	Pnt #	1	380	Exp. ID	Pnt #

Section 10

Testing and Troubleshooting

10.1 Troubleshooting

This section of the manual offers suggestions for troubleshooting hardware problems. Please read this section if you encounter a problem when installing the control panel. If these suggestions do not solve your problem or if you encounter a problem that is not listed here, contact Silent Knight Technical Support at 800-328-0103 for assistance.

10.2 Common Problems

Problem	Possible Cause / Suggested Actions
Trouble message "DBL ADDR" (Double Address) displays on LCD.	An address has been assigned to more than one detector. Correct the address following the procedure described in Section 5.9.
Auxiliary power or notification circuits have incorrect polarity.	Correct polarity. For notification and auxiliary power circuits: When in alarm or powered, terminals labeled "X" are positive, terminals labeled "O" are negative.
SLC devices are not being recognized (trouble message "Missing" displays).	<p>Check hardware connections.</p> <p>If devices are physically connected, make sure wiring is correct (see Section 5.3). For the main panel, the positive side of device must be connected to terminal 34; the negative side must be connected to Terminal 33. For SLC devices, make sure the device connects to the SLC loop via the SLC OUT terminals.</p> <p>Make sure SLC devices have been addressed properly following the procedure described in Section 5.9.</p> <p>For contact monitor modules, which are addressed using dipswitches, the dipswitch must be set to the correct address before power is applied to the SLC loop. If this procedure is not followed, the device will have an incorrect address.</p> <p>Make sure correct polarity has been observed for SLC device wiring. See Section 5.3.</p>
SLC devices are not being recognized (trouble message "Missing" displays on the annunciator).	<p>Check that SLC loop impedance is within the required range.</p> <p>To measure impedance, use the following procedure.</p> <ol style="list-style-type: none"> 1. Disconnect both wires from the terminal block at the panel (SLC devices can remain connected). 2. Measure the impedance from positive to negative and from negative to positive. Both measurements should be greater than 500 K ohms. If the installation uses T-taps, test each T-tap individually. 3. Temporarily connect the positive wire to the negative wire of the SLC loop at the point farthest from the panel (SLC devices can remain connected). 4. Measure the impedance from positive to negative and from negative to positive. Both measurements must be less than 50 ohms.

Problem	Possible Cause / Suggested Actions
<p>The panel indicates a ground fault trouble condition (trouble message "GROUND FAULT" displays).</p>	<p>An earth ground fault occurs when the panel senses an unexpected flow of current from one or more of its terminals to the earth connection (Terminal 2). Isolate the wiring that is causing the fault by removing wiring connections one at a time until the earth fault is no longer present. Pause at least five seconds after removing a wire before removing the next one.</p> <p>The panel will also go into ground fault if a computer is connected to the panel via a serial cable attached to the panel's 9-pin connector. This is a correct method for on-site communication between a panel and a computer. Ignore the ground fault message in this case. The trouble will clear automatically when you disconnect the computer from the cable</p>
<p>5496 module that has been physically connected to the panel but is not being recognized.</p>	<p>Check the status of the 5496 green LED. If it flashes in the pattern .5 sec. on / .5 sec. off, it is likely that the 5496 has not been added to the system through programming. JumpStart will add any 5496s connected to the panel. If you have already run JumpStart, 5496s can be added manually (see Section 4.9).</p> <p>Check that the correct ID for the 5496 module has been set through the dipswitches. Assign ID#1 to the first 5496 and ID#2 to the second 5496. See Section 4.9.1 for complete details.</p> <p>If the wiring between the 5496 and the panel is correct, measure the voltage from 5496 Terminal (+) to Terminal (-). Voltage should be in the range 27.2-27.4V when AC power is present.</p> <p>If the green LED is not flashing, the likely cause is incorrect wiring from between the 5496 and the panel. See Section 4.4 for wiring details.</p>

10.2.1 Event History

The event history can be useful for tracking or recalling a trouble condition.

10.3 Built-in Troubleshooting and Testing Tools

The fire control panel has several built-in testing and troubleshooting tools that can be utilized to save time while testing and troubleshooting points and SLC devices.

10.3.1 SLC Device Locator

SLC device locator can be used to locate a device on a SLC loop.

Follow these steps to locate a particular SLC device:

1. Select (Point Functions) from the Main Menu.
2. Select (SLC Dev Locator).

A message similar to the one shown in Figure 10-1 will display.

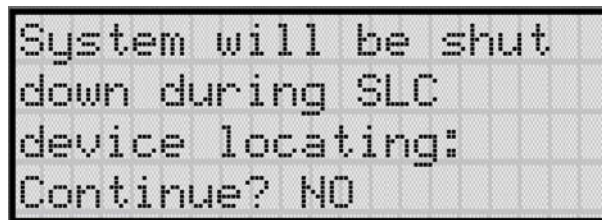

Figure 10-1 Shut Down Warning

3. Press the or arrow to toggle NO to YES then press .
- If NO is chosen you will exit back to the Point Function menu.
- If YES is chosen the system will cease normal operation leaving the premise unprotected.
4. Select the SLC loop.
5. Enter the SLC address of the device you wish to locate.
- The LED on the selected device will start flashing.
6. Press any key to exit SLC device locator function.

Note: Once you exit the system will resume normal operation.

10.3.2 SLC Multi Locator

This feature is the same as SLC Device Locator, except you can locate up to 8 devices on a single search.

Follow these instructions to locate multiple SLC devices:

1. Select (Point Functions) from the Main Menu.
2. Select (SLC Dev Locator).

A message similar to the one shown in Figure 10-1 will display.

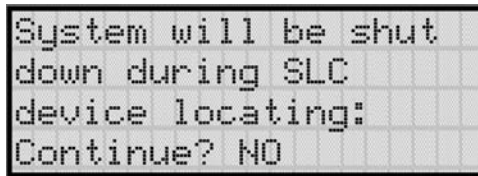

```
System will be shut
down during SLC
device locating:
Continue? NO
```

Figure 10-2 Shut Down Warning







3. Press the or arrow to toggle NO to YES then press .
- If NO is chosen you will exit back to the Point Function menu.
- If YES is chosen the system will cease normal operation leaving the premise unprotected.
4. Select the SLC loop.
5. Enter up to 8 SLC addresses for the devices you wish to locate.
- The LEDs on the selected devices will start flashing.
6. Press the to exit SLC multi-locator function.

Note: Once you exit the system will resume normal operation.

10.3.3 I/O Point Control

This feature allows you to toggle any output on or off and trip any input device. This can be useful to test a point's output mapping.

Follow these steps to control a I/O point:

1. Select  (Point Functions) from the Main Menu.
2. Select  (I/O Point Control).
3. Select the Module the point is on.
4. Enter the zone number , or press the  or  arrow to select the point you wish to test, then press .
5. Press  to generate an alarm for an input point or activate an output point.
6. To exit press .

Section 11

Installation Records

This section of the manual is for you to use if you wish to track of how points, zones, and groups have been programmed.

11.1 SLC Point Record

You can use the chart that begins below to keep track of SLC points.

Default addresses for ID: On-board: = 33

Table 11-1: Installation Record

Module	Addr	Zone / Group	Description	Module	Addr	Zone/ Group	Description
On-board	1			On-board	26		
On-board	2			On-board	27		
On-board	3			On-board	28		
On-board	4			On-board	29		
On-board	5			On-board	30		
On-board	6			On-board	31		
On-board	7			On-board	32		
On-board	8			On-board	33		
On-board	9			On-board	34		
On-board	10			On-board	35		
On-board	11			On-board	36		
On-board	12			On-board	37		
On-board	13			On-board	38		
On-board	14			On-board	39		
On-board	15			On-board	40		
On-board	16			On-board	41		
On-board	17			On-board	42		
On-board	18			On-board	43		
On-board	19			On-board	44		
On-board	20			On-board	45		
On-board	21			On-board	46		
On-board	22			On-board	47		
On-board	23			On-board	48		
On-board	24			On-board	49		
On-board	25			On-board	50		

Appendix A

Compatible Devices

A.1 Notification Appliances

For proper operation, you must use polarized devices with a Model 7628 4.7k ohm EOL resistor on each loop. All supervised notification appliances used with the control panel must be polarized.

Note: Not all devices can use the Sync feature, be sure to check Table A-1 to ensure the device you have chosen will work with this feature.

Table A-1 below lists notification appliances compatible with the fire alarm control panel. Appliances which can be synchronized indicate the type of snyc available in the columns marked Audio and/or Visual.

Table A-1: Compatible Notification Appliances

Manufacturer	Model	Audio	Visual	Type
AMSECO	SH24W-153075			Horn/Strobe
	SL24W-153075			Strobe
	H24W			Horn
Faraday	446			Vibrating Bell
	476			Vibrating Bell
	477			Single Stroke Bell
	2700 -M, -R, -T, -Y, -Z			Strobe
	2701 Series			Strobe
	2705 Series			Strobe
	2820	✓	✓	Snyc Temporal Horn/Strobe
	2821	✓	✓	Snyc Temporal Horn/Strobe
	2824	✓	✓	Horn Strobe
	5333			Multi-Tone Horn)
	5336			Multi-Tone Horn/Strobe
	5337			Multi-Tone Horn/Strobe
	5338			Multi-Tone Horn/Strobe
	5343			Single Tone Horn/Strobe
	5346			Electronic Horn with Strobe
	5347			Electronic Horn with Strobe
	5348			Single Tone Horn/Strobe
	5373			8-Tone Horn/Strobe
	5376			8-Tone Horn/Strobe
	5377			8-Tone Horn/Strobe
5378			8-Tone Horn/Strobe	
5383			8-Tone Horn/Strobe with Sync Strobe	

Table A-1: Compatible Notification Appliances

Manufacturer	Model	Audio	Visual	Type
Faraday (Cont.)	5386			8-Tone Horn/Strobe with Sync Strobe
	5387			8-Tone Horn/Strobe with Sync Strobe
	5388			8-Tone Horn/Strobe with Sync Strobe
	5405			Sync Control Unit
	5508			Single Gang Sync Strobe
	5509			Strobe
	5510			Strobe
	5511			Strobe
	5512			Strobe
	5516			Strobe
	5517			Strobe
	5518			Strobe
	5519			Strobe
	5521			4i Square Sync Strobe
	5522			4i Square Sync Strobe
	6120			Horn
	6140			Horn
	6223			Horn
	6226			Horn/Strobe
	6227			Horn/Strobe
	6228			Horn/Strobe
	6243			Electron-Mechanical Horn
	6244			Electron-Mechanical Horn
	6245			Electron-Mechanical Horn
	6246			Electron-Mechanical Horn/Strobe
	6247			Electron-Mechanical Horn/Strobe
	6248			Electron-Mechanical Horn/Strobe
	6300			Mini-Horn
	6301			Mini-Horn
	6302			Mini-Horn
	6310			Mini-Horn/Strobe
	6311			Mini-Horn/Strobe
	6312			Mini-Horn/Strobe
	6314 Series -M, -R, -T, -Y, -Z			Strobe
	6320			Sync Mini Horn/Strobe
	6321			Sync Mini Horn/Strobe
	6322			Mini Horn/Sync Strobe
	6380			8-Tone Electronic Signal/Strobe

Table A-1: Compatible Notification Appliances

Manufacturer	Model	Audio	Visual	Type
FCI	I30-3117C			Mini Horn
	I30-3147C			Mini Horn
	BLV-6			Vibrating Bell
	BLV-10			Vibrating Bell
	BLVCH			Vibrating Chime
	H12/24-FC			Horn
	H12/24W-FC			Horn
	H12/24K-FC			Horn
	HC12/24-FC			Horn
	HC12/24W-FC			Horn
	HC12/24K-FC			Horn
	P2415-FC			Horn/Strobe
	P2415W-FC			Horn/Strobe
	P2415K-FC			Horn/Strobe
	P241575-FC			Horn/Strobe
	P241575W-FC			Horn/Strobe
	P241575F-FC			Horn/Strobe
	P241575K-FC			Horn/Strobe
	P2430-FC			Horn/Strobe
	P2430W-FC			Horn/Strobe
	P2430K-FC			Horn/Strobe
	P2475-FC			Horn/Strobe
	P2475W-FC			Horn/Strobe
	P2475K-FC			Horn/Strobe
	P24110-FC			Horn/Strobe
	P24110W-FC			Horn/Strobe
	P24110K-FC			Horn/Strobe
	S2415-FC			Strobe
	S241575-FC			Strobe
	S241575W-FC			Strobe
	S241575K-FC			Strobe
	S2430-FC			Strobe
	S2430W-FC			Strobe
	S2430K-FC			Strobe
	S2475-FC			Strobe
	S2475W-FC			Strobe
	S2475K-FC			Strobe
	S24110-FC			Strobe
	S24110W-FC			Strobe
	S24110K-FC			Strobe
	MDL-FC			Sync. Module
	MDLW-FC			Sync. Module

Table A-1: Compatible Notification Appliances

Manufacturer	Model	Audio	Visual	Type
Federal Signal	450			Horn
	VALS			Horn/Strobe
Gentex	GX90-4			Horn
	GXS-4-15-1			Strobe
	GXS-4-1575			Strobe
	GX90S-4-15			Horn
	GX90S-4-1575			Horn
	HG124			Horn
	SHG24-1575			Horn/Strobe
	SHG24-15			Horn/Strobe
	GEC Series	✓	✓	Horn/Strobes
	GES Series		✓	Strobes
	GEH	✓		Horns
	GMH-24-X			Horn
	GMS-24-X			Horn/Strobe
	G0T24			Horn
	G0S24-X			Horn
	ST/HS Commander Series			Strobes & Horn/Strobes
WGMS-24-X			Horn/Strobe	
System Sensor	H12/24			Horn
	HC12/24			Horn
	MASS241			Horn/Strobe
	MASS24110ADA			Horn/Strobe
	MASS2415ADA			Horn/Strobe
	MASS2475ADA			Horn/Strobe
	P2415			Horn/Strobe
	P241575			Horn/Strobe
	P2430			Horn/Strobe
	P2475			Horn/Strobe
	P24110			Horn/Strobe
	S2415			Strobe
	S241575			Strobe
	S2430			Strobe
	S24110			Strobe
	SS24110ADA			Strobe
	SS2415ADA			Strobe
	SS2475ADA			Strobe
	PS2415ADA			Mini-Horn/Strobe
	PS241575ADA			Mini-Horn/Strobe
PS24110ADA			Mini-Horn/Strobe	

Table A-1: Compatible Notification Appliances

Manufacturer	Model	Audio	Visual	Type
System Sensor (Cont.)	PS2475ADA			Mini-Horn/Strobe
	MDL			Sync. Module
	MDLW			Sync. Module
Wheelock	46T-G4-24-R			Bell
	46T-G6-24-R			Bell
	46T-G10-24-R			Bell
	46T-G6-24-WS-24-HF-R			Strobe/Bell
	46T-G10-24-WS-24-HF-R			Strobe/Bell
	46T-G6-24-WH-24-HF-R			Strobe/Bell
	46T-G10-24-WH-24-HF-R			Strobe/Bell
	7001T-12\24-W-FR			Strobe Horn
	7002T-12\24-W-FR			Strobe Horn
	AES-DL1-R			Multitone Horn
	AES-EL1-R			Multitone Horn
	AES-DL1-WS-24-VF-R			Multitone Horn
	AES-EL1-WS-24-VF-R			Multitone Horn
	AES-DL1-WH-24-VF-R			Multitone Horn
	AES-EL1-WH-24-VF-R			Multitone Horn
	AES-DL1-WM-24-VF-R			Multitone Horn
	AES-EL1-WM-24-VF-R			Multitone Horn
	AH-24-R			Horn
	AH-24WP-R			Horn
	AMT-12\24-R			Strobe Horn
	AMT-24-LS-VFR			Strobe Horn
	AMT-24-LSM-VFR			Strobe Horn
	AMT-24-IS-VFR			Strobe Horn
	AS-24MCW-FR	✓	✓	Strobe Horn
	AS-24MCW-FW	✓	✓	Strobe Horn
	AS-2415W-FR	✓	✓	Strobe Horn
	AS-2415C-FW	✓	✓	Strobe Horn
	AS-241575W-FR	✓	✓	Strobe Horn
	AS-2475C-FW	✓	✓	Strobe Horn
	AS-24100C-FW	✓	✓	Strobe Horn
	AS-2430W-FR	✓	✓	Strobe Horn
	AS-2430C-FW	✓	✓	Strobe Horn
	AS-2475W-FR	✓	✓	Strobe Horn
	AS-24110W-FR	✓	✓	Strobe Horn
ASWP-2475W-FR	✓	✓	Strobe Horn	
SM-12\24-R			Strobe Horn Controller	
DSM-12\24-R			Strobe Horn Controller	
CF-BF1			Chime	

Table A-1: Compatible Notification Appliances

Manufacturer	Model	Audio	Visual	Type
Wheelock (Cont.)	CF-BF1-R			Chime
	CH-CF1			Chime
	CH-CF1-R			Chime
	CH-CF1-W			Chime
	CH-DF1			Chime
	CH-DF1-R			Chime
	CH-BF1-WS-24-HF-R			Strobe Chime
	CH-CF1-LS-24			Strobe Chime
	CH-CF1-MS-24			Strobe Chime
	CH-CF1-IS-24			Strobe Chime
	CH-CF1-LS-24-CFW			Strobe Chime
	CH-CF1-MS-24-CFW			Strobe Chime
	CH-CF1-IS-24-CFW			Strobe Chime
	CH-CF1-WS-24-CF-W			Strobe Chime
	CH-DF1-LS-24			Strobe Chime
	CH-DF1-MS-24			Strobe Chime
	CH-DF1-IS-24			Strobe Chime
	CH-DF1-LS-24-VFR			Strobe Chime
	CH-DF1-LSM-24-VFR			Strobe Chime
	CH-DF1-MS-24-VFR			Strobe Chime
	CH-DF1-IS-24-VFR			Strobe Chime
	CH-DF1-WM-24-VFR			Strobe Chime
	CH-DF1-WS-24-VF-R			Strobe Chime
	DSM-12/24			Sync Module
	EH-DL1-R			Electronic Horn
	EH-EL1-R Electronic Horn			Electronic Horn
	EHS-DL1-W-VF-R			Strobe Horn (single input)
	EHS-EL1-W-VF-R			Strobe Horn (single input)
	EH-DL1-WS-24-VF-R			Strobe Horn (dual input)
	EH-EL1-WS-24-VF-R			Strobe Horn (dual input)
	EH-DL1-WH-24-VF-R			Strobe Horn (dual input)
	EH-EL1-WH-24-VF-R			Strobe Horn (dual input)
	EH-DL1-WM-24-VF-R			Strobe Horn (dual input)
	EH-EL1-WM-24-VF-R			Strobe Horn (dual input)
	HSW-24-HFR			Remote Strobe
	HS2W-24-HFR			Remote Strobe
HSPW-24-HFR			Remote Strobe	
IS-24-VFR			Remote Strobe	

Table A-1: Compatible Notification Appliances

Manufacturer	Model	Audio	Visual	Type
Wheelock (Cont.)	IS1-24-VFR			Remote Strobe
	IS3-24-VFR			Remote Strobe
	ISP-24-HFR			Remote Strobe
	LS-24-VFR			Remote Strobe
	LS1-24-VFR			Remote Strobe
	LS3-24-VFR			Remote Strobe
	LSP-24-HFR			Remote Strobe
	LSM-24-VFR			Remote Strobe
	LS1M-24-VFR			Remote Strobe
	LS3M-24-VFR			Remote Strobe
	LSPM-24-VFR			Remote Strobe
	MS-24-VFR			Remote Strobe
	MS1-24-VFR			Remote Strobe
	MS3-24-VFR			Remote Strobe
	MSP-24-HFR			Remote Strobe
	MB-G6-24-R			Motor Bell
	MB-G10-24-R			Motor Bell
	MBS-G6-24-W-HF-R			Motor Bell with Strobe
	MBS-G10-24-W-HF-R			Motor Bell with Strobe
	MIZ-24-R			Mini-Horn
	MIZ-24-W			Mini-Horn
	MIZ-24-LS-VFR			Mini-Horn/Strobe
	MIZ-24-LSM-VFR			Mini-Horn/Strobe
	MIZ-24-MS-VFR			Mini-Horn/Strobe
	MIZ-24-HSW-HFR			Mini-Horn/Strobe
	MIZ-24-IS-VFR			Mini-Horn/Strobe
	MIZ-24-WS-VF-R			Mini-Horn/Strobe
	MIZ-24-WS-VF-W			Mini-Horn/Strobe
	MIZ-24-WH-VF-W			Mini-Horn/Strobe
	MIZ-24-WM-VF-W			Mini-Horn/Strobe
	MT-12/24-R			Strobe Horn
	MT-24-LS-VFR			Strobe Horn
	MT-24-LSM-VFR			Strobe Horn
	MT-24-MS-VFR			Strobe Horn
	MT-24-IS-VFR			Strobe Horn
	MT-24-SL-VFR			Strobe Horn
	MT-24-SLM-VFR			Synch. Multitone Strobe
	MT-24-WM			Strobe
	MT-24-WM-VFR			Horn

Table A-1: Compatible Notification Appliances

Manufacturer	Model	Audio	Visual	Type
Wheelock (Cont.)	NS-24MCM-FR	✓	✓	Horn Strobes
	NS-24MCW-FW	✓	✓	Horn Strobes
	NS-2415W-FR	✓	✓	Horn Strobes
	NS-241575W-FR	✓	✓	Horn Strobes
	NS-2430W-FR	✓	✓	Horn Strobes
	NS-2475W-FR	✓	✓	Horn Strobes
	NS-24110W-FR	✓	✓	Horn Strobes
	NS4-24MCW-FR	✓	✓	Horn Strobes
	NS4-24MCW-FW	✓	✓	Horn Strobes
	NS4-241575W-FR	✓	✓	Horn Strobes
	NH-12/24-R	✓		Horn
	RS-2415-HFR			Strobe
	RSP-2415-VFR			Strobe
	RS-241575-VFR			Strobe
	RSP-241575-VFR			Strobe
	RS-2430-VFR			Strobe
	RS-2430-HFR			Strobe
	RS-2475-VFR			Strobe
	RSP-2475-HFR			Strobe
	RS-24110-HFR			Strobe
	RSP-24110-HFR			Strobe
	SL-24-VFR			Synchronized Remote Strobe
	SL1-24-VFR			Synchronized Remote Strobe
	SL3-24-VFR			Synchronized Remote Strobe
	SLP-24-VFR			Synchronized Remote Strobe
	SLM-24-VFR			Synchronized Remote Strobe
	SL1M-24-VFR			Synchronized Remote Strobe
	SL3M-24-VFR			Synchronized Remote Strobe
	SLPM-24-VFR			Synchronized Remote Strobe
	SHW-24-VFR			Synchronized Remote Strobe
	SH2W-24-VFR			Synchronized Remote Strobe
	SHPW-24-VFR			Synchronized Remote Strobe
	SCM-24-R			Controller for Synchronized Strobes

Table A-1: Compatible Notification Appliances

Manufacturer	Model	Audio	Visual	Type
Wheelock (Cont.)	SM-12/24-R			Sync Module
	SR-2415-VFR			Sync Strobe
	SRP-2415-HFR			Sync Strobe
	SR-241575-VFR			Sync Strobe
	SRP-241575-VFR			Sync Strobe
	SR-2475-VFR			Sync Strobe
	SR-2475-HFR			Sync Strobe
	SR-24110-HFR			Sync Strobe
	SRP-24110-HFR			Sync Strobe
	V700IT-12\24-W-FR			Strobe Horn
	WM3T-24-FR			Remote Strobe
	WM3T-24-VFR			Remote Strobe
	WSIT-24-FR			Strobe
	WS3T-24-FR			Strobe
	WST-24-FR			Strobe

A.2 Door Holder Device

The following UL listed door holder can be used with the control panel: Model 1400 from Door Control International.

Appendix B

Special Characters Lists

This section contains tables of programmable characters that may be used for device, module, and zone names or phone numbers.

B.1 Characters used for Naming

Table B-1 list the available character and their associated numeric designator. When programming these numbers can be entered as a short cut to using the up or down arrow keys, to select characters when naming a point or zone.

Table B-1: Character Table

000	A	001	B	002	C	003	D
004	E	005	F	006	G	007	H
008	I	009	J	010	K	011	L
012	M	013	N	014	O	015	P
016	Q	017	R	018	S	019	T
020	U	021	V	022	W	023	X
024	Y	025	Z	026	a	027	b
028	c	029	d	030	e	031	f
032	g	033	h	034	i	035	j
036	k	037	l	038	m	039	n
040	o	041	p	042	q	043	r
044	s	045	t	046	u	047	v
048	w	049	x	050	y	051	z
052		053	0	054	1	055	2
056	3	057	4	058	5	059	6
060	7	061	8	062	9	063	:
064	-	065	_	066	.	067	,
068	&	069	*	070	#		

Silent Knight Fire Product Warranty and Return Policy

General Terms and Conditions

- i All new fire products manufactured by Silent Knight have a limited warranty period of 18 months from the date of manufacture against defects in materials and workmanship. See limited warranty statement for details.
- i This limited warranty does not apply to those products that are damaged due to misuse, abuse, negligence, exposure to adverse environmental conditions, or have been modified in any manner whatsoever.

Repair and RA Procedure

- i All products that are returned to Silent Knight for credit or repair require a RA (Return Authorization) number. Call Silent Knight Customer Service at 800-446-6444 or 763-493-6435 between 8:00 A.M. and 4:45 P.M. CST, Monday through Friday to obtain a return authorization number. Silent Knight Technical Support is available at 800-328-0103 between 8:00 A.M. and 6:00 P.M. CST, Monday through Friday.
- i RA number must be prominently displayed on the outside of the shipping box. See return address example under Advanced Replacement Policy.
- i Include a packing slip that has the RA number, a content list, and a detailed description of the problem should be included with each return.
- i All products returned to Silent Knight must be sent freight pre-paid. After product is processed, Silent Knight will pay for shipping product back to customer via UPS ground.
- i Return the Silent Knight product circuit board only. Products that are returned in cabinets will be charged an additional \$50 to cover the extra shipping and handling costs over board only returns. **Do not return batteries.** Silent Knight has the authority to determine if a product is repairable. Products that are deemed un-repairable will be returned to the customer.
- i Product that is returned that has a board date code more than 18 months from date of manufacture will be repaired and the customer will be assessed the standard Silent Knight repair charge for that model.

Advanced Replacement Policy

- i Silent Knight offers an option of advance replacement for fire product printed circuit boards that fail during the first 6 months of the warranty period.
- i For advance replacement of a defective board contact your local Silent Knight Distributor or call Silent Knight at 800-446-6444 or 763-493-6435 to obtain a RA (Return Authorization) number and request advanced replacement.
- i Customers without a Silent Knight account must use a MasterCard, Visa, or American Express credit card to get an advance replacement.

- i A new or refurbished board will be shipped to the customer. The customer will initially be billed for the replacement board but a credit will be issued after the repairable board is received at Silent Knight. All returned products must comply with the guidelines described under "General Terms and Conditions".
- i The defective board must be returned within 30 days of shipment of replacement board for customer to receive credit. No credit will be issued if the returned board was damaged due to misuse or abuse.
- i Repairs and returns should be sent to:
Silent Knight
Attn: Repair Department
7550 Meridian Circle Suite 100
Maple Grove, MN 55369-4927
RA Number: _____

Limited Warranty

Silent Knight warrants that the products of its manufacture shall be free from defects in materials or workmanship for 18 months from the manufacturing date code on the printed circuit board, if such goods have been properly installed, are subject to normal proper use, and have not been modified in any manner whatsoever. Upon return of the defective product, Silent Knight will at its sole discretion, either repair or replace, at no cost, such goods as may be of defective material or workmanship. Customers outside the United States are to return products to their distributor for repair.

SILENT KNIGHT SHALL NOT UNDER ANY CIRCUMSTANCES BE LIABLE FOR ANY INCIDENTAL OR CONSEQUENTIAL DAMAGES ARISING FROM LOSS OF PROPERTY OR OTHER DAMAGE OR LOSSES OWING TO THE FAILURE OF SILENT KNIGHT PRODUCTS BEYOND THE COST OF REPAIR OR REPLACEMENT OF ANY DEFECTIVE PRODUCTS.

SILENT KNIGHT MAKES NO WARRANTY OF FITNESS OR MERCHANTABILITY AND NO OTHER WARRANTY, ORAL OR WRITTEN, EXPRESS OR IMPLIED, BEYOND THE 18 MONTH WARRANTY EXPRESSLY SPECIFIED HEREIN.



**SILENT
KNIGHT**

Model 5700 Basic Operating Instructions

These Instructions must be framed and displayed next to the 5700 panel in accordance with NFPA 72 fire code for Local Protected Fire Alarm Systems. Test the system in accordance to NFPA 72. Refer to Installation Manual P/N 151295.

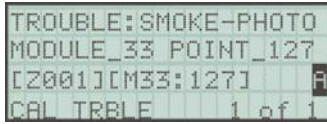
Operation	Task to Perform
Silence Alarms and Troubles	Press then enter a code if prompted. Silence LED will light.
Reset Alarms	Press then enter a code if prompted.
Acknowledge Alarms and Troubles	Press then enter a code if prompted. When the Alarm or Trouble is acknowledged an will appear in the annunciator display as shown Below. 
View Alarms and Troubles	Press the or button to view Alarms and Troubles.
Conduct a Fire Drill	<ol style="list-style-type: none"> 1. Press to access Main Menu, then enter a code if prompted. 2. Then press to select System Tests. 3. Enter code if prompted, then press to select Fire Drill. 4. Press to start the fire drill. 5. Press to end the fire drill.
View a Points Status	<ol style="list-style-type: none"> 1. Press to access Main Menu, then enter a code if prompted. 2. Then press to select Point Functions. 3. Enter code if prompted, then press to select Point Status. 4. Select the module the device is located on by using the or . Then press . 5. Enter the point number.
Check Detector Sensitivity	<ol style="list-style-type: none"> 1. Follow steps 1 through 5 for viewing a point status. 2. Press to view detector sensitivity.
Set Time and Date	<ol style="list-style-type: none"> 1. Press to access Main Menu, then enter a code if prompted. 2. Then press to select Set Time & Date. Enter a code if prompted 3. Make changes in the fields on the screen as necessary. 4. Press if you wish to keep the changes. 5. Press to set the entered time and date.
Enable / Disable a Point	<ol style="list-style-type: none"> 1. Press to access Main Menu, then enter a code if prompted. 2. Then press to select Point Functions. 3. Enter code if prompted, then press to select Disable / Enable Pt. 4. Select the module the point is located on by using the or . Then press . 5. Enter the point number.
View Event History	<ol style="list-style-type: none"> 1. Press to access Main Menu, then enter a code if prompted. 2. Press to select Event History. 3. Press the or to view events in the history buffer.
For Service call:	

Cut Along the Dotted Line

Cut Along the Dotted Line



7550 Meridian Circle
Maple Grove, MN 55369-4927
763-493-6455
1-800-328-0103
Fax: 763-493-6475

© 2003 Silent Knight
Part Number 1511295 A, 05/03